

LINEAR FLEX® Gen 3 & COB

3 MacAdam

- LED strip efficiency 155 lm/W (LF gen3) and 107lm/W (LF COB)
- Cove lighting and outdoor applications
- Uniform light due to high LEDs Density (8LEDs/unit LF gen3 and LF COB)
- 3 MacAdam: color quality and stability
- 5 color temperature: 2K7, 3K, 4K, RGBW and DW
- IP20 y IP67 (silicone extrusion)
- Dimmable flexible strip
- It can be cut to size at site
- Accessories: aluminum profile, diffuser and lenses

- Eficiencia tiras led 155 lm/W (LF gen3) y 107lm/W (LF COB)
- Iluminación de foseados y aplicaciones de exterior
- Luz uniforme gracias a la alta densidad de LEDs (8LEDs/unit LF gen3 y LF COB)
- 3 MacAdam: calidad y estabilidad de los colores
- 5 temperaturas de color: 2K7, 3K, 4K, RGBW and DW
- Modelos IP20 y IP67 (extrusión de silicona)
- Tiras flexibles dimerizables
- Se puede cortar a medida en la obra
- Perfil de aluminio, difusores y lentes como accesorios



LINEAR FLEX® Gen 3
155lm/W



LINEAR FLEX® COB
107lm/W

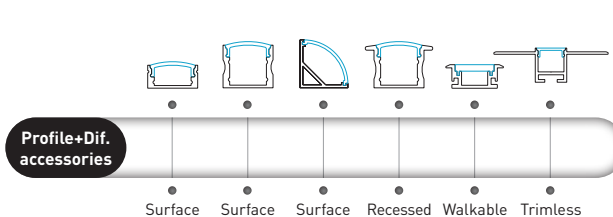
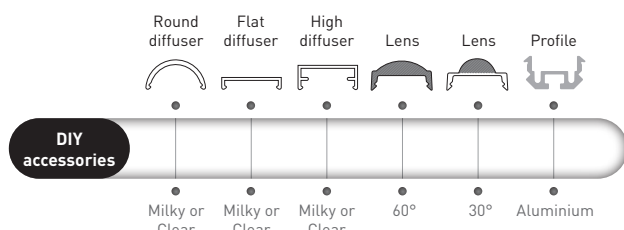
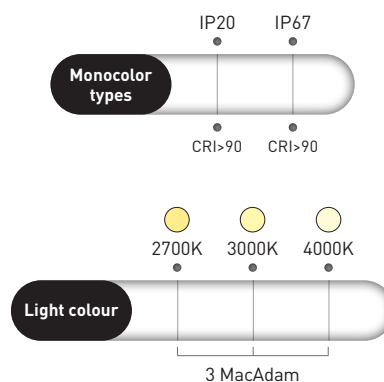
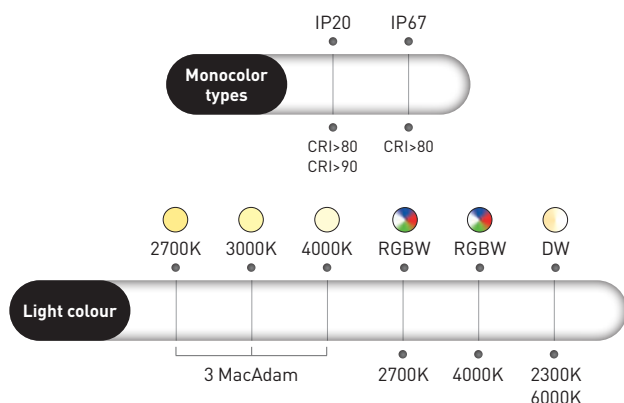

| | Linear Flex® Gen 2 | Linear Flex® Gen 3 | Linear Flex® COB |
|--------------------|--------------------|--------------------|------------------|
| Density | 6 LED/u (50mm) | 8 LED/u (50mm) | 24 LED/u (50mm) |
| LED /m | 120 LED/m | 160 LED/m | 480 LED/m |
| Power (W/m) | 14,4 W/m | 12,7 W/m | 10 W/m |
| Lumens output (4K) | 1550 lm | 1962 lm | 1070 lm |
| Efficiency (lm/W) | 108 lm/W | 155 lm/W | 107 lm/W |
| Cutting unit | 50 mm | 50 mm | 50 mm |

SPECIFICATIONS
CARACTERÍSTICAS

| | | | | | | | | | | | | | | |
|--|--------|------|------|--|-----------------|-----------------|---------------------|------------------|---------------------------|------------------------------------------|--|----|------|----|
| | 24V DC | IP20 | IP67 | | Beam Angle 120° | Beam Angle 160° | Silicone IP67 Strip | 3M Adhesive tape | L80 B10 >50.000h Ta +25°C | Ta min -20°C -4°F Ta max +45°C +113°F | | UL | RoHS | CE |
|--|--------|------|------|--|-----------------|-----------------|---------------------|------------------|---------------------------|------------------------------------------|--|----|------|----|

Gen 3 COB

| Linear Flex® Gen 3 | | | | | | | | | | | | | | | |
|-------------------------------------------------|------------|----------|------|---------------------------------------------------------------|-----------|--------------|----------------|---------------------|------------|------------|------------|------|-----------|------|--------------------|
| | Color (K) | Bin (±K) | CRI* | lm/m (lm) | lm/W (lm) | Nº of LEDs/m | LED Pitch (mm) | Cutting Length (mm) | W/Reel (W) | Length (m) | Width (mm) | SDCM | LED Model | IP | Product References |
| Monocolor CRI>80 IP20 & IP67 | | | | | | | | | | | | | | | |
| 4,4 W/m | 2700K | 60 | >80 | 634 lm | 145 | 64 | 15,6 | 125 | 22W | 5m | 8 | 3 | 2835 | IP20 | 7264000/80/2K7 |
| | 3000K | 75 | | 647 lm | 148 | | | | | | | | | | 7264000/80/3K |
| | 4000K | 120 | | 692 lm | 158 | | | | | | | | | | 7264000/80/4K |
| 9,1 W/m | 2700K | 60 | >80 | 1281 lm | 141 | 128 | 7,8 | 63 | 45W | 5m | 8 | 3 | 2835 | IP20 | 7264001/80/2K7 |
| | 3000K | 75 | | 1326 lm | 146 | | | | | | | | | | 7264001/80/3K |
| | 4000K | 120 | | 1406 lm | 154 | | | | | | | | | | 7264001/80/4K |
| 12,7 W/m | 2700K | 60 | >80 | 1781 lm | 140 | 160 | 6,3 | 50 | 64W | 5m | 8 | 3 | 2835 | IP20 | 7264002/80/2K7 |
| | 3000K | 75 | | 1848 lm | 146 | | | | | | | | | | 7264002/80/3K |
| | 4000K | 120 | | 1962 lm | 155 | | | | | | | | | | 7264002/80/4K |
| 19,2 W/m | 2700K | 60 | >80 | 2630 lm | 137 | 160 | 6,3 | 50 | 96W | 5m | 10 | 3 | 2835 | IP20 | 7264003/80/2K7 |
| | 3000K | 75 | | 2770 lm | 144 | | | | | | | | | | 7264003/80/3K |
| | 4000K | 120 | | 2900 lm | 151 | | | | | | | | | | 7264003/80/4K |
| 4,4 W/m | 2700K | 60 | >80 | 568 lm | 130 | 64 | 15,6 | 125 | 22W | 5m | 10 | 3 | 2835 | IP67 | 7264030/80/2K7 |
| | 3000K | 75 | | 580 lm | 132 | | | | | | | | | | 7264030/80/3K |
| | 4000K | 120 | | 620 lm | 142 | | | | | | | | | | 7264030/80/4K |
| 9,1 W/m | 2700K | 60 | >80 | 1130 lm | 124 | 128 | 7,8 | 63 | 45W | 5m | 10 | 3 | 2835 | IP67 | 7264031/80/2K7 |
| | 3000K | 75 | | 1170 lm | 129 | | | | | | | | | | 7264031/80/3K |
| | 4000K | 120 | | 1240 lm | 136 | | | | | | | | | | 7264031/80/4K |
| 12,7 W/m | 2700K | 60 | >80 | 1455 lm | 115 | 160 | 6,3 | 50 | 64W | 5m | 10 | 3 | 2835 | IP67 | 7264032/80/2K7 |
| | 3000K | 75 | | 1510 lm | 119 | | | | | | | | | | 7264032/80/3K |
| | 4000K | 120 | | 1603 lm | 126 | | | | | | | | | | 7264032/80/4K |
| Monocolor CRI>90 IP20 | | | | | | | | | | | | | | | |
| 12,7 W/m | 2700K | 60 | >90 | 1572 lm | 124 | 160 | 6,3 | 50 | 64W | 5m | 8 | 3 | 2835 | IP20 | 7264002/90/2K7 |
| | 3000K | 75 | | 1663 lm | 131 | | | | | | | | | | 7264002/90/3K |
| | 4000K | 120 | | 1766 lm | 139 | | | | | | | | | | 7264002/90/4K |
| 19,2 W/m | 2700K | 60 | >90 | 2367 lm | 123 | 160 | 6,3 | 50 | 96W | 5m | 10 | 3 | 2835 | IP20 | 7264003/90/2K7 |
| | 3000K | 75 | | 2493 lm | 130 | | | | | | | | | | 7264003/90/3K |
| | 4000K | 120 | | 2678 lm | 139 | | | | | | | | | | 7264003/90/4K |
| Dynamic Colors CRI>80 IP20 & IP67 | | | | | | | | | | | | | | | |
| 25,2 W/m | RGBW W-4K | - | >80 | R+G+B+W: 1330 lm R:132 lm / G:458 lm / B:112 lm / W:720 lm | 101 | 84 | 11,9 | 71 | 126W | 5m | 12 | 6 | 5050 LED | IP20 | 7264202/11-4K |
| 25,2 W/m | RGBW W-4K | - | >80 | R+G+B+W: 1189 lm R:118 lm / G:410 lm / B:100 lm / W:645 lm | 90 | 84 | 11,9 | 71 | 126W | 5m | 14 | 6 | 5050 LED | IP67 | 7264232/11-4K |
| 25,2 W/m | RGBW W-2K7 | - | >80 | R+G+B+W: 1300 lm R:132 lm / G:458 lm / B:112 lm / W:640 lm | 90 | 84 | 11,9 | 71 | 126W | 5m | 12 | 6 | 5050 LED | IP20 | 7264202/11-2K7 |
| 25,2 W/m | RGBW W-2K7 | - | >80 | R+G+B+W: 1162 lm R:118 lm / G:410 lm / B:100 lm / W:574 lm | 81 | 84 | 11,9 | 71 | 126W | 5m | 14 | 6 | 5050 LED | IP67 | 7264232/11-2K7 |
| 20,0 W/m | DW 2K3-6K | - | >80 | 2300K:1270 lm | 127 | 224 | 8,9 | 71 | 100W | 5m | 10 | 6 | 2835 | IP20 | 7264201/2K3-6K |
| | | | | 6000K:1450 lm | 145 | | | | | | | | | | 7264231/2K3-6K |
| 20,0 W/m | DW 2K3-6K | - | >80 | 2300K:1020 lm | 102 | 224 | 8,9 | 71 | 100W | 5m | 12 | 6 | 2835 | IP67 | 7264231/2K3-6K |
| | | | | 6000K:1150 lm | 115 | | | | | | | | | | 7264231/2K3-6K |

| Linear Flex® COB | | | | | | | | | | | | | | | |
|--------------------------------------------|-----------|----------|------|-----------|-----------|--------------|----------------|---------------------|------------|------------|------------|------|-----------|------|--------------------|
| | Color (K) | Bin (±K) | CRI* | lm/m (lm) | lm/W (lm) | Nº of LEDs/m | LED Pitch (mm) | Cutting Length (mm) | W/Reel (W) | Length (m) | Width (mm) | SDCM | LED Model | IP | Product References |
| Monocolor CRI>90 IP20 & IP67 | | | | | | | | | | | | | | | |
| 10 W/m | 2700K | - | >90 | 995 lm | 100 | 480 | - | 50 | 50W | 5 | 8 | 3 | COB | IP20 | 7266001/90/2K7 |
| | 3000K | - | | 1006 lm | 106 | | | | | | | | | | 7266001/90/3K |
| | 4000K | - | | 1070 lm | 107 | | | | | | | | | | 7266001/90/4K |
| 10 W/m | 2700K | - | >90 | 950 lm | 95 | 480 | - | 50 | 50W | 5 | 10 | 3 | COB | IP67 | 7266031/90/2K7 |
| | 3000K | - | | 990 lm | 101 | | | | | | | | | | 7266031/90/3K |
| | 4000K | - | | 950 lm | 100 | | | | | | | | | | 7266031/90/4K |

Color temperature conform to ANSI C78.377A.
Temperatura de color según normativa ANSI C78.377A.

**MEASURES
MEDIDAS**

CRI>80 - CRI>90 (IP20)

4,4W/m (64 LEDs/m)

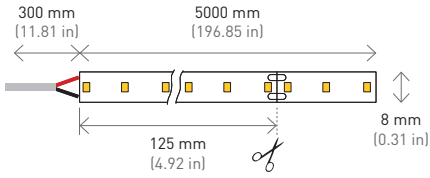

9,1W/m (128 LEDs/m)

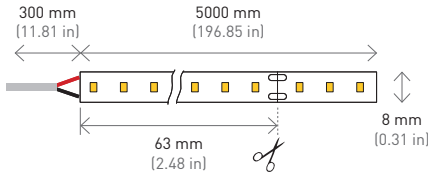

12,7W/m (160 LEDs/m)

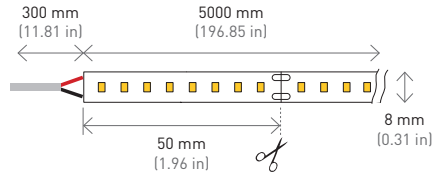

19,2W/m (160 LEDs/m)

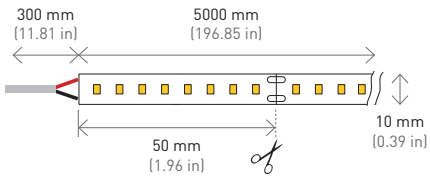

CRI>80 IP67

4,4W/m (64 LEDs/m)

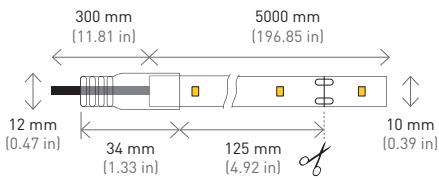

9,1W/m (128 LEDs/m)

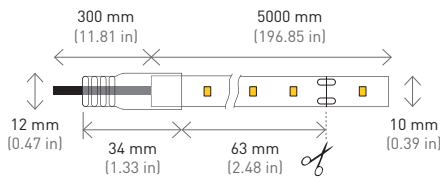

12,7W/m (160 LEDs/m)

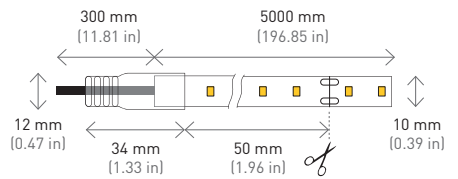

DYNAMIC COLORS

RGBW 25,2W/m (84 LEDs/m) IP20

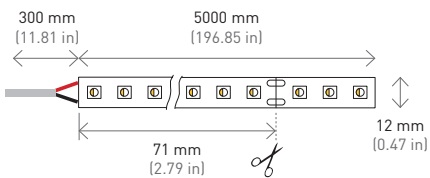

RGBW 25,2W/m (84 LEDs/m) IP67

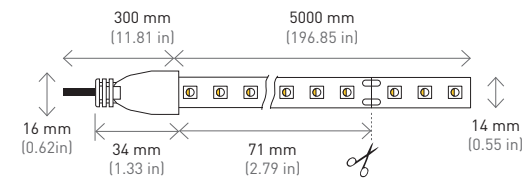

DW 20W/m (224 LEDs/m) IP20

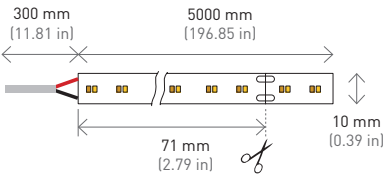

DW 20W/m (224 LEDs/m) IP67

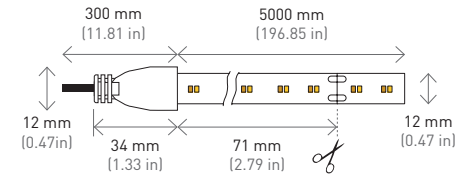

CRI>90 COB

10W/m (480 LEDs/m) IP20

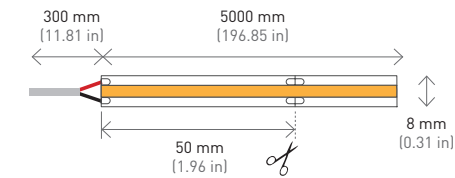

10W/m (480 LEDs/m) IP67

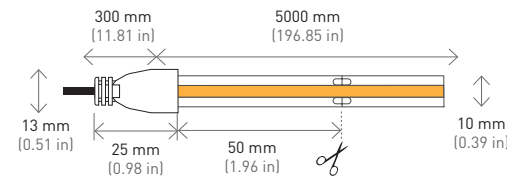

LINEAR FLEX® RANGE (max. lm/m)
GAMA LINEAR FLEX® (max. lm/m)

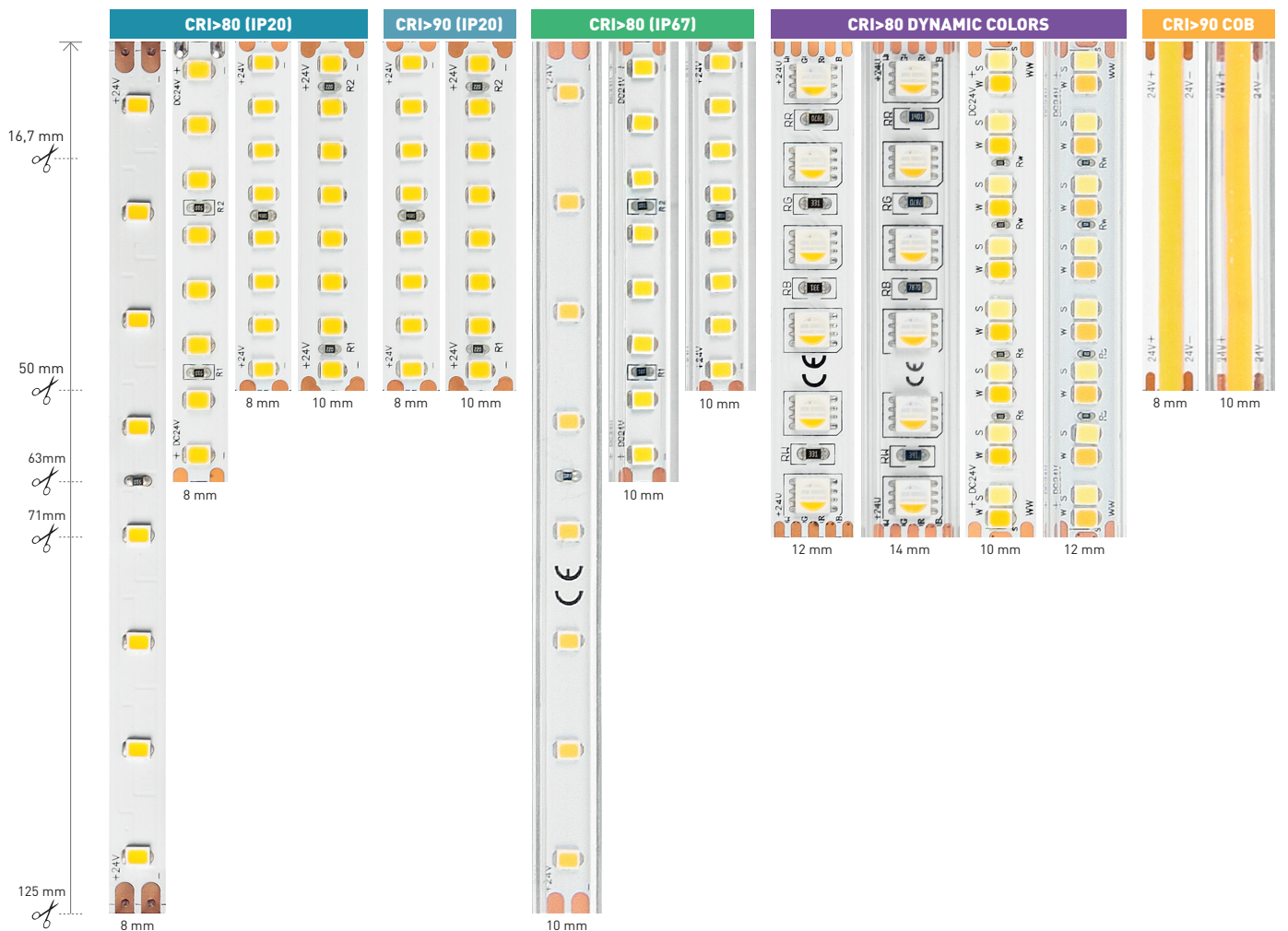
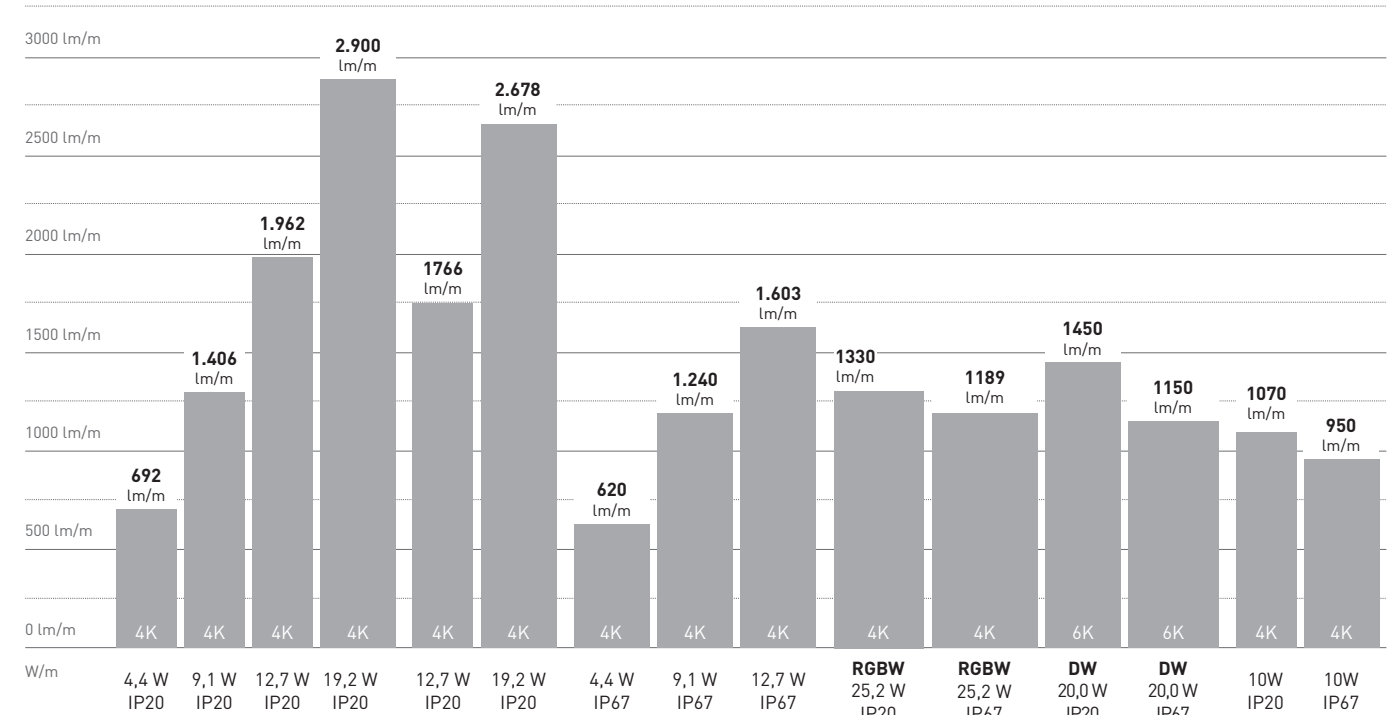

ACCESSORIES DIY
ACCESORIOS DIY

Choose your diffuser or lens according to your lighting project
Escoje el difusor o lente que se adapte mejor a tu proyecto lumínico

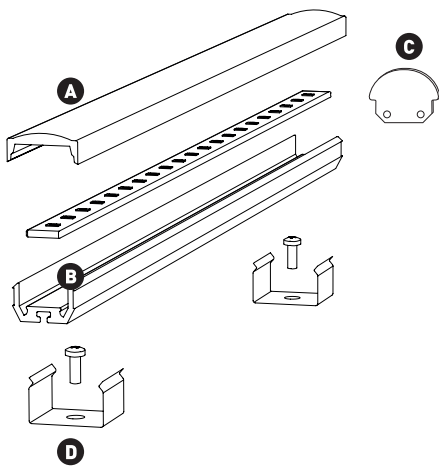

A Diffusers and lens
Difusores y lentes

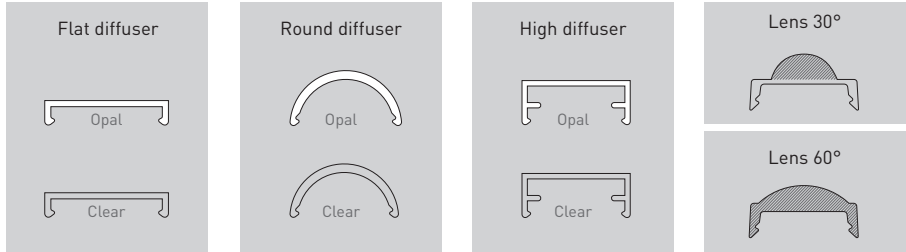

B Aluminium profile
Perfil de aluminio

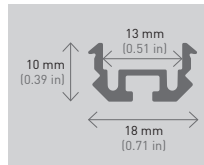

C End caps
Tapas finales

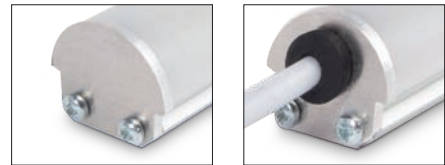

D Brackets
Soportes











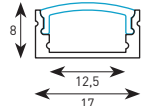

| | | | | | |
|--|--|-----------------------------------------------------------------------------------------------|--|--|------------------------------------------------------------------|
| | | Al. Profile + Clip + Flat milky cover. Perfil AL. + Clip + Cubierta plana opal. | | | Al. Profile + Clip + 60° Lens. Perfil AL. + Clip + Lente 60°. |
| | | Al. Profile + Clip + High milky cover. Perfil AL. + Clip + Cubierta opal alta. | | | Al. Profile + Clip + 30° Lens. Perfil AL. + Clip + Lente 30°. |
| | | Al. Profile + Clip + Round clear cover. Perfil AL. + Clip + Cubierta redonda transparente. | | | Al. Profile + Clip. Perfil AL. + Clip. |

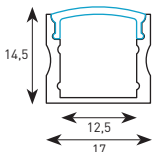
LED STRIP TABLE COMPATIBLE WITH END CAPS
TABLA DE TIRAS LED COMPATIBLES CON TAPAS FINALES

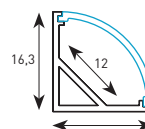
| Monocolor IP20 | | | | CRI>90 | | IP67 | | |
|----------------|-------------|-----------|-----------|------------|------------|--------|--------|---------|
| 4,4W/m | 9,1W/m | 12,7W/m | 19,2W/m | 12,7W/m | 19,2W/m | 4,4W/m | 9,1W/m | 12,7W/m |
| ✓ | ✓ | ✓ | ✓ | ✓ | ✓ | ✓ | ✓ | ✓ |
| RGBW (IP20) | RGBW (IP67) | DW (IP20) | DW (IP67) | COB (IP20) | COB (IP67) | | | |
| 25,2W/m | 25,2W/m | 20W/m | 20W/m | 10W/m | 10W/m | | | |
| ✓ | ✗ | ✓ | ✗ | ✓ | ✗ | | | |

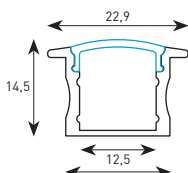

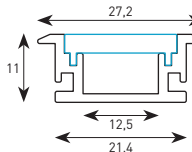
ACCESSORIES 2m PROFILE WITH DIFFUSER
ACCESORIOS PERFIL CON DIFUSOR 2m

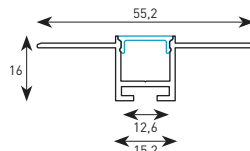
| | | Measures Profile (mm) | Mounting type | Strips width LED (mm) | Description | Reference |
|-------------------------------------------------------------------------------------|-------------------------------------------------------------------------------------|-----------------------|-------------------------------------------|-----------------------|----------------------------------------------------------------------------------------------------------|-------------|
|  |  | 17x9x2000 | Surface Superficie | máx 12,5 | Anodized aluminum profile + PC Opal diffuser (2m) Perfil de aluminio anodizado + Difusor PC Opal (2m) | 7269921/C02 |
| | | | | | 2 end caps, 1 with hole, 1 without hole 2 Tapas finales, 1 con agujero, 1 sin agujero | 7269951 |
| | | | | | 4 stainless steel mounting clips 4 Clips de montaje inox | 7269981 |
|  |  | 17x15x2000 | Surface Superficie | máx 12,5 | Anodized aluminum profile + PC Opal diffuser (2m) Perfil de aluminio anodizado + Difusor PC Opal (2m) | 7269922/C02 |
| | | | | | 2 end caps, 1 with hole, 1 without hole 2 Tapas finales, 1 con agujero, 1 sin agujero | 7269952 |
| | | | | | 4 stainless steel mounting clips 4 Clips de montaje inox | 7269982 |
|  |  | 16x16x2000 | Surface Superficie | máx 12 | Anodized aluminum profile + PC Opal diffuser (2m) Perfil de aluminio anodizado + Difusor PC Opal (2m) | 7269923/C02 |
| | | | | | 2 end caps, 1 with hole, 1 without hole 2 Tapas finales, 1 con agujero, 1 sin agujero | 7269953 |
| | | | | | 4 stainless steel mounting clips 4 Clips de montaje inox | 7269983 |
|  |  | 23x15x2000 | Recessed Empotrado | máx 12,5 | Anodized aluminum profile + PC Opal diffuser (2m) Perfil de aluminio anodizado + Difusor PC Opal (2m) | 7269924/C02 |
| | | | | | 2 end caps, 1 with hole, 1 without hole 2 Tapas finales, 1 con agujero, 1 sin agujero | 7269954 |
| | | | | | 4 stainless steel mounting clips 4 Clips de montaje inox | 7269984 |
|  |  | 27x11x2000 | Recessed and walkable Empotrado y pisable | máx 12,5 | Anodized aluminum profile + PC Opal diffuser (2m) Perfil de aluminio anodizado + Difusor PC Opal (2m) | 7269925/C02 |
| | | | | | 2 end caps, 1 with hole, 1 without hole 2 Tapas finales, 1 con agujero, 1 sin agujero | 7269955 |
| | | | | | 4 stainless steel mounting clips 4 Clips de montaje inox | 7269985 |
|  |  | 55x16x2000 | Trimless | máx 12,5 | Anodized aluminum profile + PC Opal diffuser (2m) Perfil de aluminio anodizado + Difusor PC Opal (2m) | 7269926/C02 |
| | | | | | 2 end caps, 1 with hole, 1 without hole 2 Tapas finales, 1 con agujero, 1 sin agujero | 7269956 |

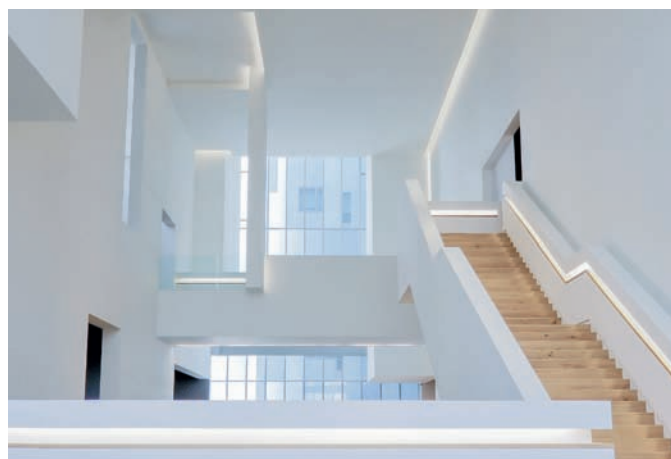

MONOCOLOR CONNECTIONS
CONEXIONES MONOCOLOR

A

MONOCOLOR NO DIMMABLE
MONOCOLOR SIN DIMERIZAR

Below you see the maximum reels which can be connected in parallel to the 24 V DC - 320W power supply. Maximum 5 m from the power supply to the first reel connection.

Ver tabla adjunta para número máximo de bobinas conectadas en paralelo a fuente de alimentación de 24 V DC - 320W. Máximo 5 m desde la fuente de alimentación a la primera bobina.

MONOCOLOR NO DIMMABLE
MONOCOLOR SIN DIMERIZAR

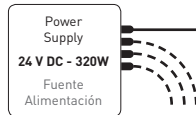

A

B

DIMMABLE WITH LINEARdrive 720
DIMERIZABLE CON LINEARdrive 720

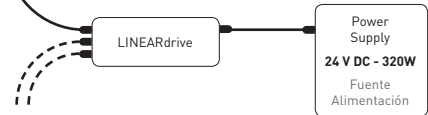

B

DIMMABLE WITH LINEARdrive 720
DIMERIZABLE CON LINEARdrive 720

Below you see the maximum reels which can be connected in parallel to the LINEARdrive 720 (PSU 24 V DC - 320W). Maximum 5 m from the power supply to the first reel connection.

Ver tabla adjunta para número máximo de bobinas conectadas en paralelo a LINEARdrive 720 (PSU 24 V DC - 320W). Máximo 5 m desde la fuente de alimentación a la primera bobina.

MAXIMUM REELS CONNECTION TABLE
TABLA CON MÁXIMO DE BOBINAS CONECTADAS

(with a 24 V DC - 320W power supply)
(con fuente de alimentación de 24 V DC - 320W)

| Model | Linear Flex Gen 3 | | | | COB |
|---------------|-------------------|--------|---------|---------|-------|
| | 4,4W/m | 9,1W/m | 12,7W/m | 19,2W/m | 10W/m |
| Reel lenght | 5 m | 5 m | 5 m | 5 m | 5m |
| Max. Nº Reels | 14 | 7 | 5 | 3 | 6 |

Values calculated without considering voltage drop.
Datos calculados sin caída de tensión.

DYNAMIC WHITE CONNECTIONS
CONEXIONES BLANCO DINÁMICO

LINEARdrive 222D 200W 24V DC DMX (2 channels)
LINEARdrive 220D 200W 24V DC DALI (2 channels)

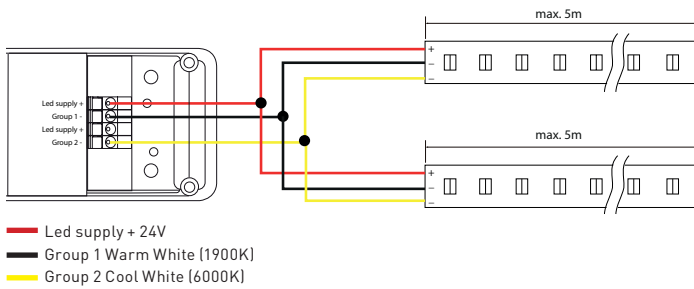

Dynamic White

Maximum 2 reels of 5 m of Linear Flex 100W DW with power supply 320W and LINEARdrive 222D/220D. Maximum 5 m from the power supply to the first reel connection.

Máximo 2 bobinas de 5 m de Linear Flex 100W DW con fuente de alimentación de 320W y LINEARdrive 222D/220D. Máximo 5 m desde la fuente de alimentación a la primera bobina.

RGBW CONNECTIONS
CONEXIONES RGBW

LINEARdrive 720D DMX/DALI 24 V DC

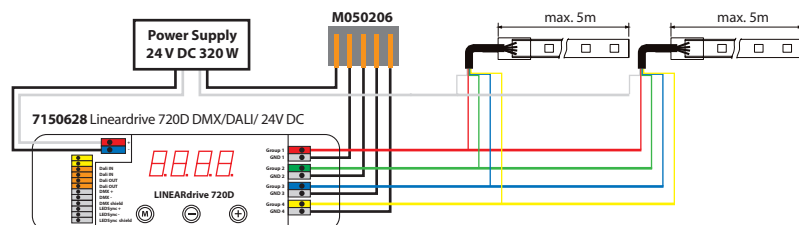

RGBW

Maximum 2 reels of 5 m of Linear Flex 126W RGBW with power supply 320W and LINEARdrive 720D. Maximum 5 m from the power supply to the first reel connection.

Máximo 2 bobinas de 5 m de Linear Flex 126W RGBW con fuente de alimentación de 320W y LINEARdrive 720D. Máximo 5 m desde la fuente de alimentación a la primera bobina.

REFERENCES
REFERENCIAS

| | | | | | |
|---------------------------------------------------------------------|---------|--------|------|-------|----------------|
| Linear Flex® Monocolor CRI>80 IP20 | 4,4W/m | 22W/5m | IP20 | 2700K | 7264000/80/2K7 |
| | | | | 3000K | 7264000/80/3K |
| | | | | 4000K | 7264000/80/4K |
| | 9,1W/m | 45W/5m | IP20 | 2700K | 7264001/80/2K7 |
| | | | | 3000K | 7264001/80/3K |
| | | | | 4000K | 7264001/80/4K |
| | 12,7W/m | 64W/5m | IP20 | 2700K | 7264002/80/2K7 |
| | | | | 3000K | 7264002/80/3K |
| | | | | 4000K | 7264002/80/4K |
| | 19,2W/m | 96W/5m | IP20 | 2700K | 7264003/80/2K7 |
| | | | | 3000K | 7264003/80/3K |
| | | | | 4000K | 7264003/80/4K |
| Linear Flex® Monocolor CRI>90 IP20 | 12,7W/m | 64W/5m | IP20 | 2700K | 7264002/90/2K7 |
| | | | | 3000K | 7264002/90/3K |
| | | | | 4000K | 7264002/90/4K |
| | 19,2W/m | 96W/5m | IP20 | 2700K | 7264003/90/2K7 |
| | | | | 3000K | 7264003/90/3K |
| | | | | 4000K | 7264003/90/4K |
| Linear Flex® Monocolor CRI>80 IP67 | 4,4W/m | 22W/5m | IP67 | 2700K | 7264030/80/2K7 |
| | | | | 3000K | 7264030/80/3K |
| | | | | 4000K | 7264030/80/4K |
| | 9,1W/m | 45W/5m | IP67 | 2700K | 7264031/80/2K7 |
| | | | | 3000K | 7264031/80/3K |
| | | | | 4000K | 7264031/80/4K |
| | 12,7W/m | 64W/5m | IP67 | 2700K | 7264032/80/2K7 |
| | | | | 3000K | 7264032/80/3K |
| | | | | 4000K | 7264032/80/4K |

| | | | | | |
|-------------------------------------------------|---------|---------|-------|---------------|----------------|
| Linear Flex® RGBW CRI>80 | 25,2W/m | 126W/5m | IP20 | 4000K | 7264202/11-4K |
| | 25,2W/m | 126W/5m | IP67 | 4000K | 7264232/11-4K |
| | 25,2W/m | 126W/5m | IP20 | 2700K | 7264202/11-2K7 |
| | 25,2W/m | 126W/5m | IP67 | 2700K | 7264232/11-2K7 |
| Linear Flex® DW CRI>80 | 20,0W/m | 100W/5m | IP20 | 2300K-6000K | 7264201/2K3-6K |
| | 20,0W/m | 100W/5m | IP67 | 2300K-6000K | 7264231/2K3-6K |
| Linear Flex® COB CRI>90 | 10W/m | 50W/5m | IP20 | 2700K | 7266001/90/2K7 |
| | | | 3000K | 7266001/90/3K | |
| | 10W/m | 50W/5m | IP67 | 2700K | 7266031/90/2K7 |
| | | | 3000K | 7266031/90/3K | |
| | | | 4000K | 7266031/90/4K | |

Due to tolerances of the production process the total lengths could change slightly.
Debido a las tolerancias del proceso de producción las longitudes totales pueden cambiar ligeramente.

CONNECTIONS REFERENCES
REFERENCIAS CONEXIONES

| | | | | | | | | | | | | |
|--------------------------|----------------------------------------------|---|--|---|--|-------------------------------------------------------|---|---|--|---|--|--|
| 1 | | 2 | | 3 | | 4 | | 5 | | 6 | | |
| For Monocolor | | | | | | Para Monocolor | | | | | | |
| M050338 | Kit 30 cm wire (IP20) | | | | | Kit cable alimentación 30 cm (IP20) | | | | | | |
| M050350 * | Kit 30 cm wire + End cap (IP67) | | | | | Kit cable alimentación 30 cm + tapa final (IP67) | 1 | | | | | |
| For RGBW | | | | | | Para RGBW | | | | | | |
| M050378 | 30 cm wire (IP20) | | | | | Cable alimentación 30 cm (IP20) | 2 | | | | | |
| M050387 * | 30 cm wire + End cap (IP67) | | | | | Cable alimentación 30 cm + tapa final (IP67) | 3 | | | | | |
| For Dynamic White | | | | | | Para Blanco Dinámico | | | | | | |
| M050388 | Kit 30 cm wire (IP20) | | | | | Kit cable alimentación 30 cm (IP20) | | | | | | |
| M050374 * | Kit 30 cm wire + End cap (IP67) | | | | | Kit cable alimentación 30 cm + tapa final (IP67) | 4 | | | | | |
| For COB | | | | | | Para COB | | | | | | |
| M050338 | Kit 30 cm wire (IP20) | | | | | Kit cable alimentación 30 cm (IP20) | 1 | | | | | |
| M050389 * | Kit 30 cm wire + End cap (IP67) | | | | | Kit cable alimentación 30 cm + tapa final (IP67) | 5 | | | | | |
| M050390 | Silicone Glue (100 gr.) for LED Strip (IP67) | | | | | Pegamento de Silicona (100 gr.) para tiras LED (IP67) | 6 | | | | | |

* To ensure the IP67 sealing degree of the LED strip, use silicone glue. Ref.[M050390]
* Para asegurar el grado de estanqueidad IP67 de la tira LED utiliza el pegamento de silicona. Ref.[M050390]

COMPATIBLE CONNECTORS TABLE
TABLA DE CONECTORES COMPATIBLES

| Linear Flex® | Type | IP | Width | POWER WIRE | Linear Flex® | Type | IP | Width | POWER WIRE |
|---------------|----------------|------|-------|------------|-------------------------|--------------|------|-------|------------|
| 7264000/80/.. | 4,4W/m | IP20 | 8 mm | M050338 | 7264202/11-4K | 25,2W/m RGBW | IP20 | 12 mm | M050378 |
| 7264001/80/.. | 9,1W/m | IP20 | 8 mm | M050338 | 7264232/11-4K | 25,2W/m RGBW | IP67 | 14 mm | M050387 |
| 7264002/80/.. | 12,7W/m | IP20 | 8 mm | M050338 | 7264202/11-2K7 | 25,2W/m RGBW | IP20 | 12 mm | M050378 |
| 7264003/80/.. | 19,2W/m | IP20 | 10 mm | M050338 | 7264232/11-2K7 | 25,2W/m RGBW | IP67 | 14 mm | M050387 |
| 7264002/90/.. | 12,7W/m CRI>90 | IP20 | 8 mm | M050338 | 7264201/2K3-6K | 20,0W/m DW | IP20 | 10 mm | M050388 |
| 7264003/90/.. | 19,2W/m CRI>90 | IP20 | 10 mm | M050338 | 7264231/2K3-6K | 20,0W/m DW | IP67 | 12 mm | M050374 |
| 7264030/80/.. | 4,4W/m | IP67 | 10 mm | M050350 | Linear Flex® COB | | | | |
| 7264031/80/.. | 9,1W/m | IP67 | 10 mm | M050350 | 7266001/90/.. | 10W/m | IP20 | 8 mm | M050338 |
| 7264032/80/.. | 12,7W/m | IP67 | 10 mm | M050350 | 7266031/90/.. | 10W/m | IP67 | 10 mm | M050389 |

ACCESSORIES DIY REFERENCES
REFERENCIAS ACCESORIOS DIY

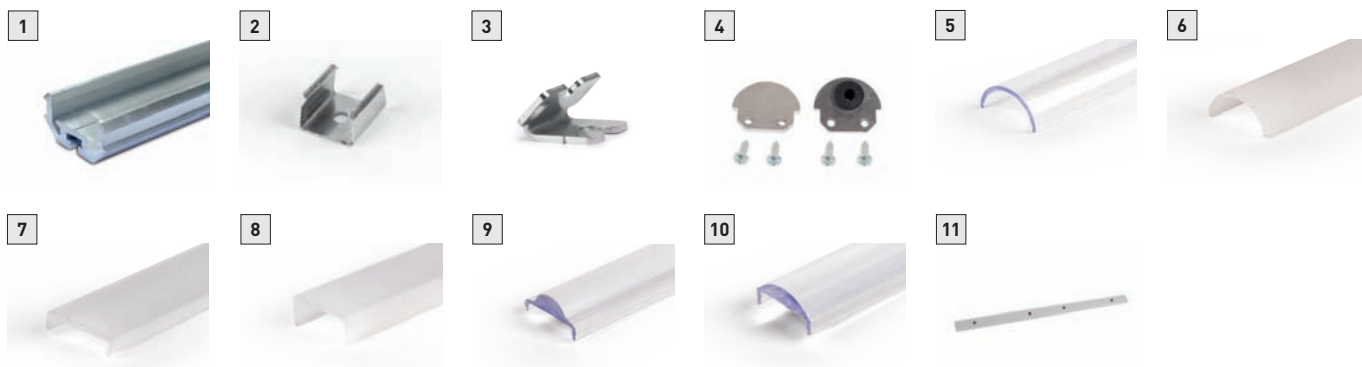

| | | | |
|--------------------|---------------------------------------------------|-------------------------------------------------------------------|-----------|
| 8010400/C12 | Aluminium profile for lens | Perfil aluminio para lente | 1 |
| M170023 | Mounting inox clips for aluminium profile | Clips inox de sujeción para perfil aluminio | 2 |
| M170040 | Bracket 15° | Soporte 15° | |
| M170041 | Bracket 30° | Soporte 30° | |
| M170028 | Bracket 45° | Soporte 45° | 3 |
| 7259100/C12 | 2 end cap kit for round diffuser & lens (30°/60°) | Kit 2 tapas finales para lentes (30°/60°) y para difusor circular | 4 |
| M130367/C01 | Round clear cover for aluminium profile | Difusor circular transparente para perfil aluminio | 5 |
| M130367/C02 | Round milky diffuser for aluminium profile | Difusor circular opal para perfil aluminio | 6 |
| M130342/C01 | 30° clear lens for aluminium profile | Lente transparente 30° para perfil aluminio | 9 |
| M130343/C01 | 60° clear lens for aluminium profile | Lente transparente 60° para perfil aluminio | 10 |
| 7259101/C12 | 2 end cap kit for flat diffuser | Kit 2 tapas finales para difusor plano | |
| M130368/C01 | Flat clear cover for aluminium profile | Difusor plano transparente para perfil aluminio | |
| M130368/C02 | Flat milky diffuser for aluminium profile | Difusor plano opal para perfil aluminio | 7 |
| 7259102/C12 | 2 end cap kit for high diffuser | Kit 2 tapas finales para difusor alto | |
| M130369/C01 | High clear diffuser for aluminium profile | Difusor alto y transparente para perfil aluminio | |
| M130369/C02 | High milky diffuser for aluminium profile | Difusor alto y opal para perfil aluminio | 8 |
| 7259110/C12 | Mechanical junction between aluminium profiles | Unión mecánica entre perfiles de aluminio | 11 |

ACCESSORIES REFERENCES
REFERENCIAS ACCESORIOS



| | | | |
|----------------|----------------------------------------------|--------------------------------------------------|-----------|
| M050328 | Thermal conductive tape (25m) | Cinta termoconductora (25m) | 12 |
| M050337 | Mounting clips 12 mm 10 u. | Clips sujeción 12 mm 10 u. | 13 |
| M050336 | 3M adhesive tape 3 m | Cinta adhesiva 3M 3 m | 14 |
| 7150131 | 24V 300W RGB controller + Remote control RF | Controlador RGB 24V 300W + Mando a distancia RF | 15 |
| 7150127 | 24V 300W RGB amplifier | Amplificador RGB 24V 300W | 16 |
| 7150129 | 24V 300W RGBW controller + Remote control RF | Controlador RGBW 24V 300W + Mando a distancia RF | |
| 7150132 | 24V 300W RGBW amplifier | Amplificador RGBW 24V 300W | |
| 7150627 | LINEARdrive 180D DMX | LINEARdrive 180D DMX | 17 |
| 7150628 | LINEARdrive 720D DMX/DALI | LINEARdrive 720D DMX/DALI | 18 |
| M050206 | WAGO connector 5 wires entry | Conector WAGO 5 vías | 19 |

ACCESSORIES 2m PROFILE WITH DIFFUSER REFERENCES
REFERENCIAS ACCESORIOS PERFIL CON DIFUSOR 2m

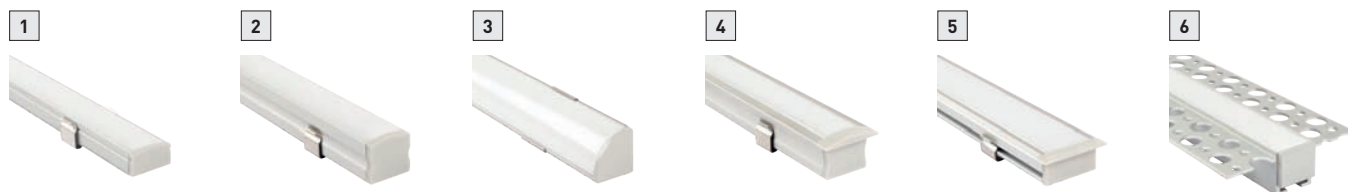

| | | | |
|--------------------|---------------------------------------------------|-----------------------------------------------------|----------|
| 7269921/C02 | Anodized aluminum profile + PC Opal diffuser (2m) | Perfil de aluminio anodizado + Difusor PC Opal (2m) | 1 |
| 7269951 | 2 end caps, 1 with hole, 1 without hole | 2 Tapas finales, 1 con agujero, 1 sin agujero | |
| 7269981 | 4 stainless steel mounting clips | 4 Clips de montaje inox | |
| 7269922/C02 | Anodized aluminum profile + PC Opal diffuser (2m) | Perfil de aluminio anodizado + Difusor PC Opal (2m) | 2 |
| 7269952 | 2 end caps, 1 with hole, 1 without hole | 2 Tapas finales, 1 con agujero, 1 sin agujero | |
| 7269982 | 4 stainless steel mounting clips | 4 Clips de montaje inox | |
| 7269923/C02 | Anodized aluminum profile + PC Opal diffuser (2m) | Perfil de aluminio anodizado + Difusor PC Opal (2m) | 3 |
| 7269953 | 2 end caps, 1 with hole, 1 without hole | 2 Tapas finales, 1 con agujero, 1 sin agujero | |
| 7269983 | 4 stainless steel mounting clips | 4 Clips de montaje inox | |
| 7269924/C02 | Anodized aluminum profile + PC Opal diffuser (2m) | Perfil de aluminio anodizado + Difusor PC Opal (2m) | 4 |
| 7269954 | 2 end caps, 1 with hole, 1 without hole | 2 Tapas finales, 1 con agujero, 1 sin agujero | |
| 7269984 | 4 stainless steel mounting clips | 4 Clips de montaje inox | |
| 7269925/C02 | Anodized aluminum profile + PC Opal diffuser (2m) | Perfil de aluminio anodizado + Difusor PC Opal (2m) | 5 |
| 7269955 | 2 end caps, 1 with hole, 1 without hole | 2 Tapas finales, 1 con agujero, 1 sin agujero | |
| 7269985 | 4 stainless steel mounting clips | 4 Clips de montaje inox | |
| 7269926/C02 | Anodized aluminum profile + PC Opal diffuser (2m) | Perfil de aluminio anodizado + Difusor PC Opal (2m) | 6 |
| 7269956 | 2 end caps, 1 with hole, 1 without hole | 2 Tapas finales, 1 con agujero, 1 sin agujero | |

Power supply see page 318
Fuentes alimentación ver página 318

 To control the luminaires via Bluetooth see page 314
Para controlar las luminarias vía Bluetooth consultar página 314