

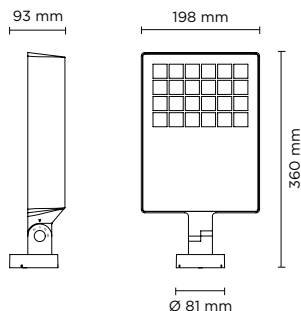

101503

ZEUS MAXI

Floodlight for outdoor installation on a façade/wall, with 355° swivel base and allowing horizontal adjustment of +90° / -40°. Phospho-chromatised and polyester powder coated die-cast copper-free aluminium base and head, tempered safety glass, moulded silicone gaskets and o-rings, with screws in stainless steel. Swivel joint with graduated scale and mechanical aiming lock. Built-in LED driver, with 24 CREE "XP-G2" LED. IP66 rating.



light source*	light beam options	lumen output (lm)	lumin. efficacy (lm/w)
3000°K warm-white			
high-power led	15°	3.648	96.00
high-power led	35°	3.539	93.13
high-power led	55°	3.372	88.75
4000°K neutral-white			
high-power led	15°	3.743	98.50
high-power led	35°	3.634	95.63
high-power led	55°	3.468	91.25

Finish color options:

- Textured Grey RAL 9006
- Anthracite Grey RAL 7016
- Matt Black (on request)

Technical features



Technical data

Wattage	38 WATT
IP Rating	IP66
IK Rating	IK09
Material	High corrosion resistance die-cast copper-free aluminum body
Coating	Polyester powder coating with phosphochromating pre-finish
Light source	24 CREE "XP-G2" LED
Screws	Stainless steel
Transformer	Electrical power supply 220/240V 50/60Hz built-in
Gasket	Silicone rubber
Glass	Tempered
Cable gland	M16 rubber grommet
Power cable	1 mt. power cable included
Gross weight	3,50 Kg

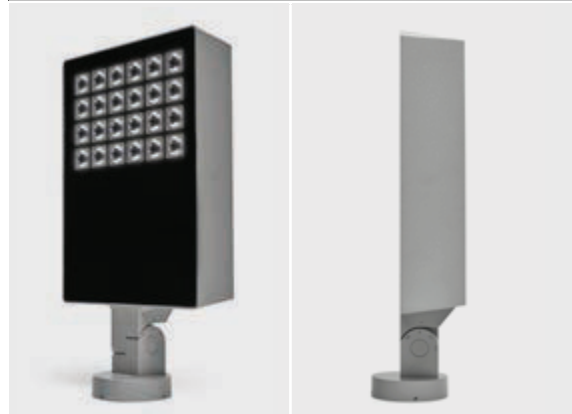



101507

ZEUS MAXI SYMM

Floodlight for outdoor installation on a façade/wall, with 355° swivel base and allowing horizontal adjustment of +90° / -40°. Phospho-chromatised and polyester powder coated die-cast copper-free aluminium base and head, tempered safety glass, moulded silicone gaskets and o-rings, with screws in stainless steel. Symmetrical wide light distribution. Swivel joint with graduated scale and mechanical aiming lock. Built-in LED driver, with 120 x mid-power SAMSUNG 2835 LED. IP65 rating.

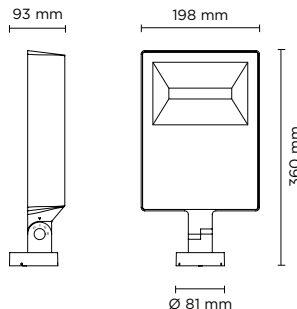

light source*	light beam options	lumen output (lm)	lumin. efficacy (lm/w)
3000°K warm-white			
mid-power led	110°	3.900	92.86
4000°K neutral-white			
mid-power led	110°	3.940	93.80

Finish color options:

- Textured Grey RAL 9006
- Anthracite Grey RAL 7016
- Matt Black (on request)

Technical features

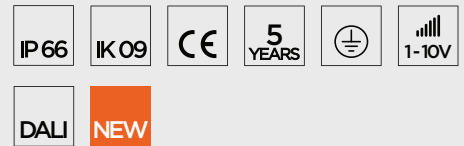

Technical data

Wattage	42 WATT
IP Rating	IP66
IK Rating	IK09
Material	High corrosion resistance die-cast copper-free aluminum body
Coating	Polyester powder coating with phosphochromating pre-finish
Light source	120 x mid-power SAMSUNG 2835 LED
Screws	Stainless steel
Transformer	Electrical power supply 220/240V 50/60Hz built-in
Gasket	Silicone rubber
Glass	Tempered
Cable gland	M16 rubber grommet
Power cable	1 mt. power cable included
Gross weight	3,50 Kg

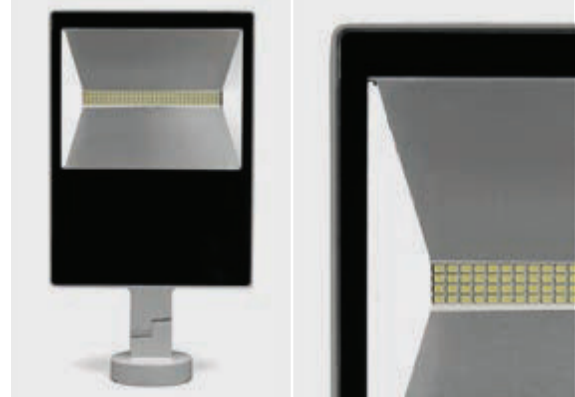



Technical features

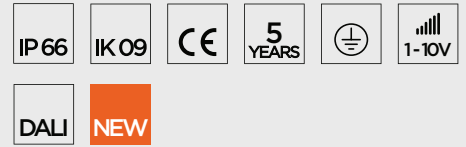

Technical data

Wattage	42 WATT
IP Rating	IP66
IK Rating	IK09
Material	High corrosion resistance die-cast copper-free aluminum body
Coating	Polyester powder coating with phosphochromating pre-finish
Light source	120 x mid-power SAMSUNG 2835 LED
Screws	Stainless steel
Transformer	Electrical power supply 220/240V 50/60Hz built-in
Gasket	Silicone rubber
Glass	Tempered
Cable gland	M16 rubber grommet
Power cable	1 mt. power cable included
Gross weight	3,50 Kg

101508

ZEUS MAXI ASYMM

Floodlight for outdoor installation on a façade/wall, with 355° swivel base and allowing horizontal adjustment of +90° / -40°. Phospho-chromatised and polyester powder coated die-cast copper-free aluminium base and head, tempered safety glass, moulded silicone gaskets and o-rings, with screws in stainless steel. Asymmetrical wide light distribution. Swivel joint with graduated scale and mechanical aiming lock. Built-in LED driver, with 120 x mid-power SAMSUNG 2835 LED. IP65 rating.

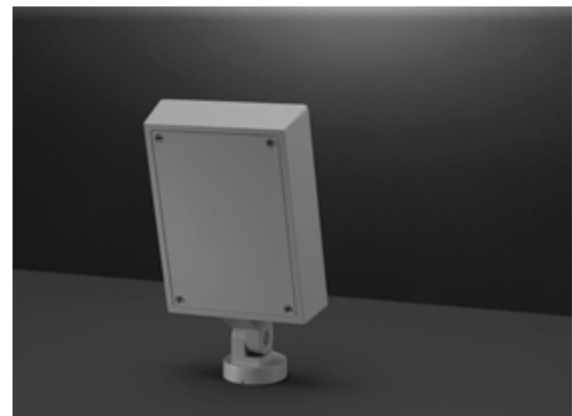
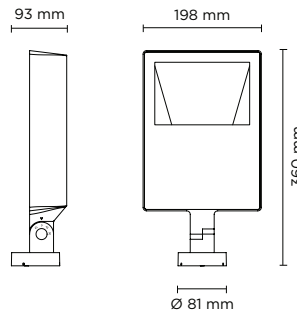

light source*	light beam options	lumen output (lm)	lumin. efficacy (lm/w)
3000°K warm-white			
mid-power led	110°x70°	2.995	71.31
4000°K neutral-white			
mid-power led	110°x70°	3.010	71.67

Finish color options:

