

206001

HYDROFLOOR MINI INVISA

ALL BLACK APPEARANCE.

Round compact ground-recessed luminaire for outdoor installation, Phospho-chromatised and polyester powder coated die-cast copper-free aluminium body and stainless steel AISI 304 frame, tempered safety glass, moulded silicone gasket, non-visible stainless steel screws. Built-in LED driver 220-240V 50-60Hz, with 4 CREE XP-G2 LED + special optics with "invisa-light" technology. IP67 rating.

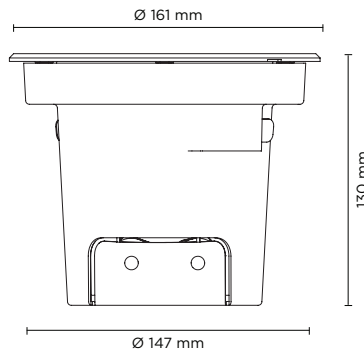

light source	light beam options	lumen output (lm)	lumin. efficacy (lm/w)
3000°K warm-white			
high-power led	15°	595	85.00
high-power led	35°	565	80.71
high-power led	55°	536	76.57
4000°K neutral-white			
high-power led	15°	630	90.00
high-power led	35°	598	85.43
high-power led	55°	568	81.14

Finish color options:

■ Matt Black

■ Stainless Steel (on request)

Technical features



Technical data

Wattage	7 WATT
IP Rating	IP67
IK Rating	IK10
Material	High corrosion resistance die-cast copper-free aluminum body
Coating	Polyester powder coating with phosphochromating pre-finish
Trim	Stainless steel AISI 304
Light source	NR. 4 x 1.5W CREE "XP-G2" LED
Transformer	Electronic power supply 220/240V 50/60Hz built-in
Screws	Stainless steel
Optics	Special optics with "invisa-light" technology
Gasket	Silicone rubber
Glass	Tempered
Cable gland	Double M20
Static weight resistance	Max 2000 Kg
Power cable	1 mt. neoprene power cable included
Gross weight	2,00 Kg
Included	Polypropilene housing for recess included

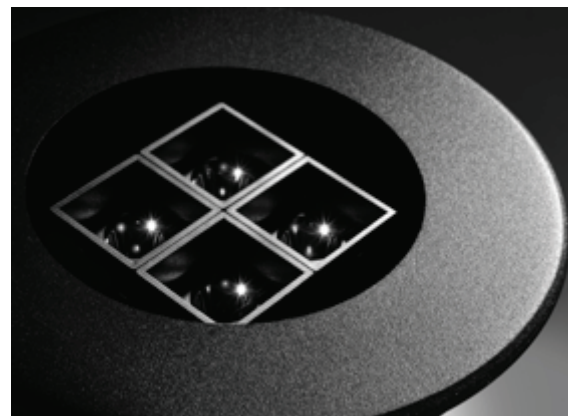

Stainless steel finish trim available on request

Sliding hooking system for recessing box





206002

HYDROFLOOR MEDIUM INVISA

ALL BLACK APPEARANCE.

Round compact ground-recessed luminaire for outdoor installation, Phospho-chromatised and polyester powder coated die-cast copper-free aluminium body and stainless steel AISI 304 frame, tempered safety glass, moulded silicone gasket, non-visible stainless steel screws. Built-in LED driver 220-240V 50-60Hz, with 9 CREE XP-G2 LED + special optics with "invisa-light" technology. IP67 rating.

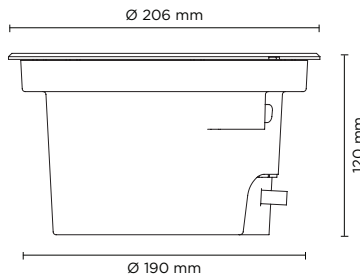

light source	light beam options	lumen output (lm)	lumin. efficacy (lm/w)
3000°K warm-white			
high-power led	15°	1.296	86.40
high-power led	35°	1.231	82.07
high-power led	55°	1.170	78.00
4000°K neutral-white			
high-power led	15°	1.350	90.00
high-power led	35°	1.282	85.47
high-power led	55°	1.218	81.20

Finish color options:

■ Matt Black

□ Stainless Steel (on request)

Technical features

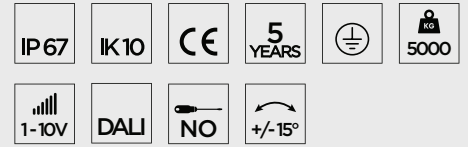

Technical data

Wattage	15 WATT
IP Rating	IP67
IK Rating	IK10
Material	High corrosion resistance die-cast copper-free aluminum body
Coating	Polyester powder coating with phosphochromating pre-finish
Trim	Stainless steel AISI 304
Light source	NR. 9 x 1.5W CREE "XP-G2" LED
Transformer	Electronic power supply 220/240V 50/60Hz built-in
Screws	Stainless steel
Optics	Special optics with "invisa-light" technology
Gasket	Silicone rubber
Glass	Tempered
Cable gland	Double M20
Static weight resistance	Max 5000 Kg
Power cable	1 mt. neoprene power cable included
Gross weight	3,00 Kg
Included	Polypropilene housing for recess included



Stainless steel finish trim available on request

Sliding hooking system for recessing box





206003

HYDROFLOOR MAXI INVISA

ALL BLACK APPEARANCE.

Round compact ground-recessed luminaire for outdoor installation, Phospho-chromatised and polyester powder coated die-cast copper-free aluminium body and stainless steel AISI 304 frame, tempered safety glass, moulded silicone gasket, non-visible stainless steel screws. Built-in LED driver 220-240V 50-60Hz, with 16 CREE XP-G2 LED + special optics with "invisa-light" technology. IP67 rating.

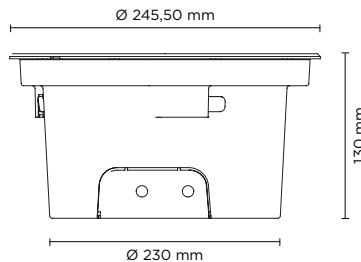

light source	light beam options	lumen output (lm)	lumin. efficacy (lm/w)
3000°K warm-white			
high-power led	15°	2.232	82.67
high-power led	35°	2.120	78.52
high-power led	55°	2.014	74.59
4000°K neutral-white			
high-power led	15°	2.325	86.11
high-power led	35°	2.208	81.78
high-power led	55°	2.098	77.69

Finish color options:

■ Matt Black

■ Stainless Steel (on request)

Technical features

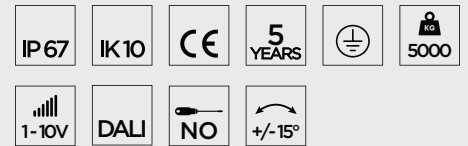

Technical data

Wattage	27 WATT
IP Rating	IP67
IK Rating	IK10
Material	High corrosion resistance die-cast copper-free aluminum body
Coating	Polyester powder coating with phosphochromating pre-finish
Trim	Stainless steel AISI 304
Light source	NR. 16 x 1.5W CREE "XP-G2" LED
Transformer	Electronic power supply 220/240V 50/60Hz built-in
Screws	Stainless steel
Optics	Special optics with "invisa-light" technology
Gasket	Silicone rubber
Glass	Tempered
Cable	Double M20 cable gland
Static weight resistance	Max 5000 Kg
Power cable	1 mt. neoprene power cable included
Gross weight	4,50 Kg
Included	Polypropilene housing for recess included



Stainless steel finish trim available on request

Sliding hooking system for recessing box





206004

HYDROFLOOR MEGA INVISA

ALL BLACK APPEARANCE.

Round compact ground-recessed luminaire for outdoor installation, Phospho-chromatised and polyester powder coated die-cast copper-free aluminium body and stainless steel AISI 304 frame, tempered safety glass, moulded silicone gasket, non-visible stainless steel screws. Built-in LED driver 220-240V 50-60Hz, with 25 CREE XP-G2 LED + special optics with "invisa-light" technology. IP67 rating.

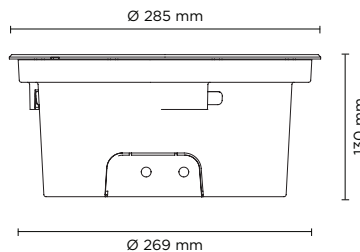

light source	light beam options	lumen output (lm)	lumin. efficacy (lm/w)
3000°K warm-white			
high-power led	15°	3.720	90.73
high-power led	35°	3.534	86.19
high-power led	55°	3.357	81.88
4000°K neutral-white			
high-power led	15°	3.875	94.51
high-power led	35°	3.681	89.78
high-power led	55°	3.497	85.29

Finish color options:

■ Matt Black

■ Stainless Steel (on request)

Technical features

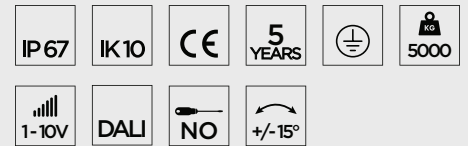

Technical data

Wattage	41 WATT
IP Rating	IP67
IK Rating	IK10
Material	High corrosion resistance die-cast copper-free aluminum body
Coating	Polyester powder coating with phosphochromating pre-finish
Trim	Stainless steel AISI 304
Light source	NR. 25 x 1.5W CREE "XP-G2" LED
Transformer	Electronic power supply 220/240V 50/60Hz built-in
Screws	Stainless steel
Optics	Special optics with "invisa-light" technology
Gasket	Silicone rubber
Glass	Tempered
Cable gland	Double M20 cable gland
Static weight resistance	Max 5000 Kg
Power cable	1 mt. neoprene power cable included
Gross weight	6,00 Kg
Included	Polypropilene housing for recess included

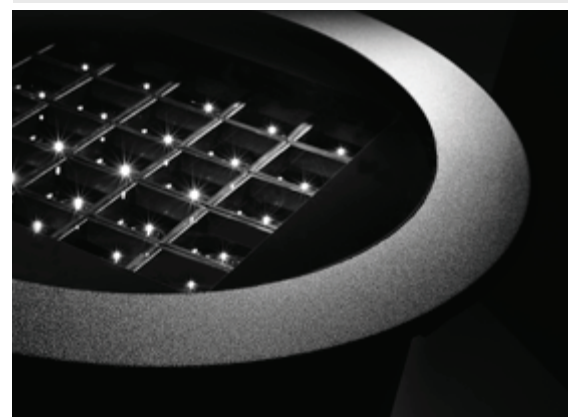

Stainless steel finish trim available on request

Sliding hooking system for recessing box

