

AQUA-70-Ex-LED

IP 66 / IP 68 / zone 1, 21

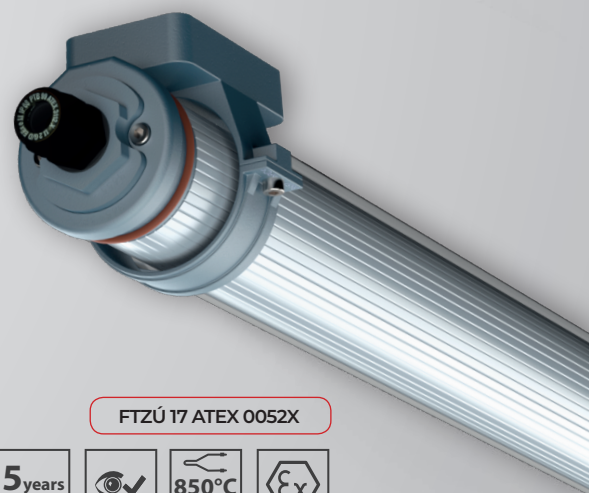

FTZÚ 17 ATEX 0052X



Application: Dustproof and water-tight lighting fixture AQUA-70-Ex-LED is designed for lighting of areas with danger of explosion. The lighting fixture is certified by FTZU Ostrava-Radvanice (certificate type FTZU 17 ATEX 0052X).

Ballast: EP – electronic 110-254 V, 50-60 Hz AC, 220-250 V, 0 Hz DC

Light source: LED, 4000K, CRI +80

Housing: Tube with outer diameter of 70 mm and wall thickness of 4 mm made from clear PC - IK10 (polycarbonate)

Fastening: Surface wall or ceiling mounting by means of plastic or stainless steel mounting brackets (not standard equipment) or suspension by means of cable suspenders

Standard equipment: 1pc EX plastic cable gland M20x1,5 for diameter of cable 7-13mm, 1pc EX plastic sealing plug

Calculated lifetime – LED modules:

L80B50 ta50 – 45 000h

AQUA-70-Ex-LED-D

II 2G Ex db eb mb op is IIC T4 Gb

II 2D Ex tb op is IIIC T62°C Db

AQUA-70-Ex-LED-WOD

II 2G Ex eb mb op is IIC T4 Gb

II 2D Ex tb op is IIIC T62°C Db

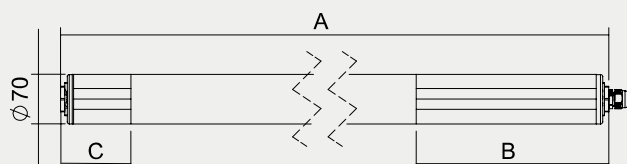

Order number	Name	Lighting fixture luminous flux (lm)	Power input (W)	Rated power output	Ta max (°C)	Equivalent*	Dimensions of lighting fixture A x B x C (mm)	Weight (kg)
084240	AQUA-70-Ex-LED-D-2750-118-4K	2107	16	132	50	X	1149x425x65	2,9
084200	AQUA-70-Ex-LED-D-4000-118-4K	3061	28	109	50	1x36W	1149x425x65	2,9
084241	AQUA-70-Ex-LED-D-5500-136-4K	4175	30	139	50	1x58W	1709x425x65	4,7
084201	AQUA-70-Ex-LED-D-8000-136-4K	5985	51	117	50	X	1709x425x65	4,7
084242	AQUA-70-Ex-LED-WOD-2750-118-4K	2107	16	132	50	X	1149x425x65	2,9
084202	AQUA-70-Ex-LED-WOD-4000-118-4K	3061	28	109	50	1x36W	1149x425x65	2,9
084243	AQUA-70-Ex-LED-WOD-5500-136-4K	4175	30	139	50	1x58W	1709x425x65	4,7
084203	AQUA-70-Ex-LED-WOD-8000-136-4K	5985	51	117	50	X	1709x425x65	4,7

Tolerance of luminous flux and power input of the lighting fixture +/- 10%

* Luminaires are not a direct replacement. They may vary in length. The required lighting of the room must be verified by calculation.

AQUA-70-Ex-LED

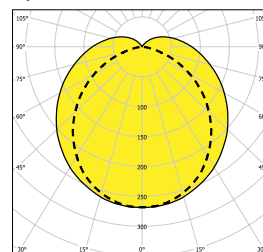

— C0-C180 - - - C90-C270

Lighting fixtures for areas with danger of explosions

Accessories on request

	008096 Plastic cable gland Ex M20x1.5 008097 Plastic nut WISKA EMUG 20 M20x1.5 008090 Sealing plug Ex M20x1.5 007047N Flat sealing ring EPDM 26x20x1.5 mm		Direct mounting 064898 Stainless steel mounting bracket AQUA-70 (1 pc) for direct surface mounting
	Direct mounting 053627 Stainless steel mounting bracket AQUA-70 (1 pc)		Direct mounting 053629 Mounting PC bracket AQUA-70, dark grey (1pc) Suspended mounting 051127 Cable suspension AQUA-70 (2 pcs) 053629 Mounting PC bracket AQUA-70, dark grey (1pc)
	Direct mounting 053628 Stainless steel mounting bracket AQUA-70 (1 pc) Suspended mounting 051134 Cable suspension AQUA-70 (2 pcs) stainless steel 053628 Stainless steel mounting bracket AQUA-70 (1 pc)		Direct mounting 053630 Mounting PC bracket AQUA-70, bright grey (1pc) Suspended mounting 051127 Cable suspension AQUA-70 (2 pcs) 053630 Mounting PC bracket AQUA-70, bright grey (1pc)

Lighting fixture detail

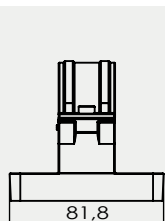

053630

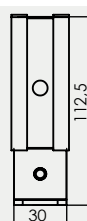
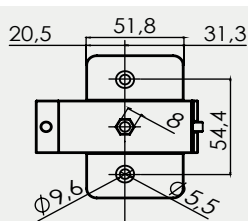
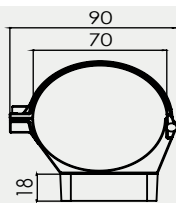

053627

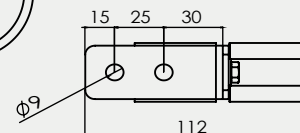
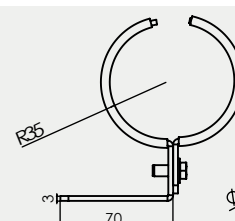

Marking system and overview of approved variants of lighting fixtures

AQUA-70-Ex-LED-D-XXXX-YYY	lighting fixture type for standard operation with disconnecter
AQUA-70-Ex-LED-WOD-XXXX-YYY	lighting fixture type for standard operation without disconnecter
XXXX*	indicates value of luminous flux (lumen) 4000/8000
YYY*	indicates type of lighting fixture housing 118/136

On request

3000/4000/6000K - colour temperature

1/3 F - single-phase or three phase through wiring connection, max. diameter of wires 4 mm²

Stadard order number	EM-1H	EM-3H	MULTI-1H	MULTI-3H	DALI	1F	3F
084200	X	X	X	X	X	084200 1F	X
084201	X	X	X	X	X	084201 1F	X
084202	X	X	X	X	X	084202 1F	X
084203	X	X	X	X	X	084203 1F	X

Use of lighting fixtures in areas with danger of explosion

	Marking of external influences	Area classification	
		Marking	Directive
Danger of explosion of flammable dust	BE3N1	ZONE 21.22	ČSN EN 60079-14, ČSN EN 60079-10-2
Danger of explosion of flammable gases and vapours	BE3N2	ZONE 1.2	ČSN EN 60079-14, ČSN EN 60079-10-1