

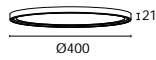

## LPR40

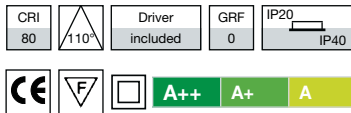

Code	Nominal lumen	W	CCT	Driver
<b>LPR40/3K</b>	2900	28	3000K	ON-OFF
<b>LPR40/4K</b>	3100	28	4000K	ON-OFF

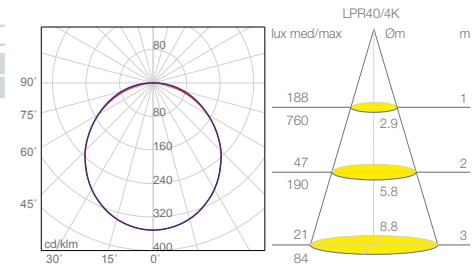
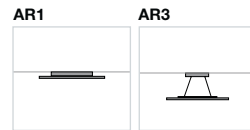

## LPR50

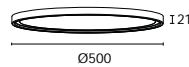

Code	Nominal lumen	W	CCT	Driver
<b>LPR50/3K</b>	4000	38	3000K	ON-OFF
<b>LPR50/4K</b>	4200	38	4000K	ON-OFF

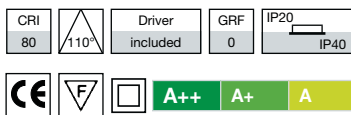
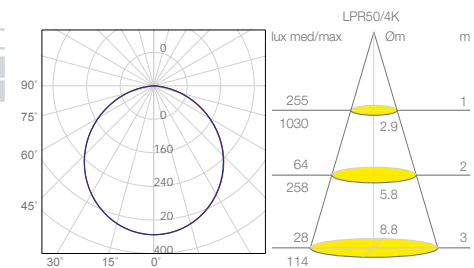
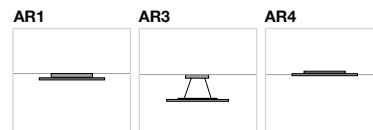

## LPR60

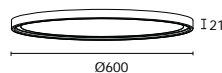

Code	Nominal lumen	W	CCT	Driver
<b>LPR60/3K</b>	4400	44	3000K	ON-OFF
<b>LPR60/4K</b>	4600	44	4000K	ON-OFF

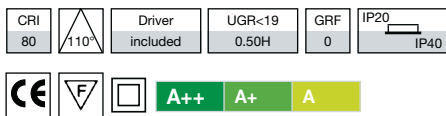
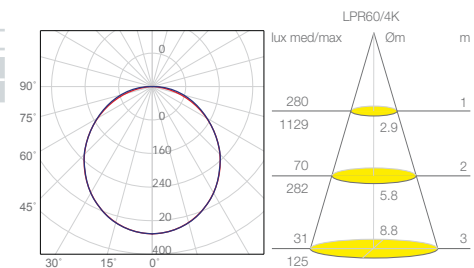
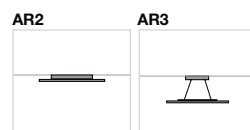

Accessori indispensabili, da ordinare separatamente. Vedi pag.25 / Essential accessories, to be ordered separately. See p.25

Code	Descrizione	Description	LPR40	LPR50	LPR60
<b>AR1</b>	Kit a plafone e parete per LPR40-LPR50	Kit for ceiling and wall mounted version for LPR40-LPR50	•	•	
<b>AR2</b>	Kit a plafone e parete per LPR60	Kit for ceiling and wall mounted version for LPR60			•
<b>AR3</b>	Kit a sospensione per LPR40-LPR50-LPR60	Kit for suspended version for LPR40-LPR50-LPR60	•	•	•
<b>AR4</b>	Kit telaio per LPR50	Kit with structure for false ceiling for LPR50		•	

Versioni prodotto disponibili su richiesta / Product versions available upon request

Code	Descrizione	Description
<b>LPR40/..1</b>	<b>LPR50/..1</b>	<b>LPR60/..1</b>
Con driver ON-OFF Made in Italy		
With Made in Italy ON-OFF driver		
Con driver PUSH/DIM 1-10V Made in Italy		
With Made in Italy PUSH/DIM 1-10V driver		
Con driver DALI Made in Italy		
With Made in Italy DALI driver		

Kit emergenza disponibile su richiesta. Vedi pag.341 / Emergency kit available upon request. See p.341

Code	Descrizione	Description
<b>KIT EM/LED/1H</b>	Kit emergenza per LED 1 ora - Batt.7.2V - 1.5Ah	Emergency kit for LED 1 hour - Batt.7.2V - 1.5Ah
<b>KIT EM/LED/3H</b>	Kit emergenza per LED 3 ore - Batt.7.2V - 4Ah	Emergency kit for LED 3 hours - Batt.7.2V - 4Ah



INDOOR LED  
Pannello LED tondo / Round LED panel



LPR40+AR1

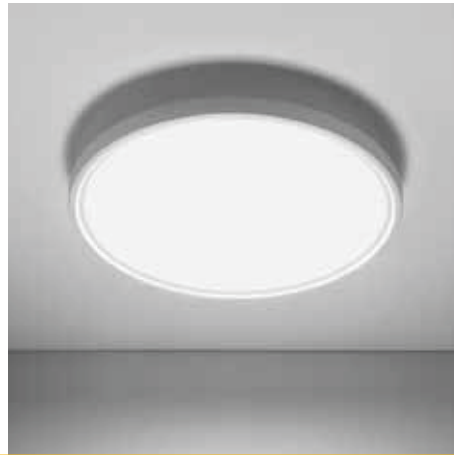

LPR50+AR1



LPR60+AR2



LPR40+AR3



LPR50+AR3



LPR60+AR3



LPR50+AR4



**LPR:** Accessori indispensabili, da ordinare separatamente / *Essential accessories, to be ordered separately*

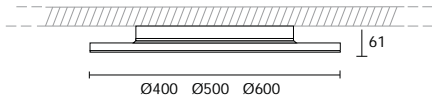

Accessorio per fissaggio a plafone e a parete, con driver integrato, da fissare direttamente al retro del pannello per installazione a soffitto e a parete.

*Accessory for ceiling or wall mounted installation, with driver included, to fix directly on the back of LED panel for ceiling and wall mounted installation.*

**AR1** Kit Ø270mm a plafone e parete per LPR40-LPR50

*Kit Ø270mm for ceiling and wall mounted version for LPR40- LPR50*

**AR2** Kit Ø340mm a plafone e parete per LPR60

*Kit Ø340mm for ceiling and wall mounted version for LPR60*

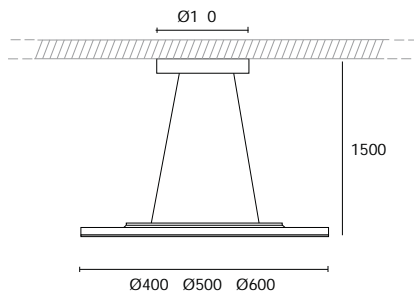

n.3 tiranti in acciaio da fissare direttamente al retro del pannello e al rosone Ø180x55mm. Completo di cavo di alimentazione bianco da 1.5m. Massima estensione del tirante 1500mm. Rosone da fissare direttamente a soffitto mediante staffa. Alimentatore da inserire nel rosone.

*n.3 steel support ropes to fix directly on the back of LED panel and to the rose Ø180x55mm. 1,5m white supply cable included. Maximum extension of support ropes is 1500mm. Rose to fix directly to the ceiling through a bracket. Power supply to be placed into the rose.*

**AR3** Kit a sospensione per LPR40-LPR50-LPR60

*Kit for suspended version for LPR40 - LPR50 - LPR60*

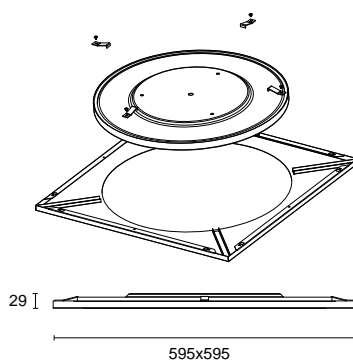

Telaio in alluminio verniciato bianco (RAL9010) gofrato, per controsoffitto modulo 60x60: telaio da fissare in appoggio direttamente su controsoffitto per l'installazione del pannello LPR50. Peso LPR50 con telaio 2.75Kg.

*Structure in white-embossed painted aluminium (RAL9010) for modular 60x60 false ceiling: structure to lay into the false ceiling for the installation of LED panel LPR50. Total weight of LPR50 LED panel with structure is 2,75Kg.*

**AR4** Kit telaio per LPR50

*Kit with structure for false ceiling for LPR50*