

# LINEA MAXI

design U.T. EGOLUCE

Linea luminosa LED IP40 da incasso con corpo diffusore in metacrilato bianco satinato e dissipatore in estruso di alluminio. Cavo di alimentazione 40 cm. Possibilità di montaggio a parete o soffitto.

Recessed LED profile IP40 with diffusing frame in white satin methacrylate and anodized aluminium heatsink. Supply cable 40 cm. Suitable for ceiling or wall mounting.

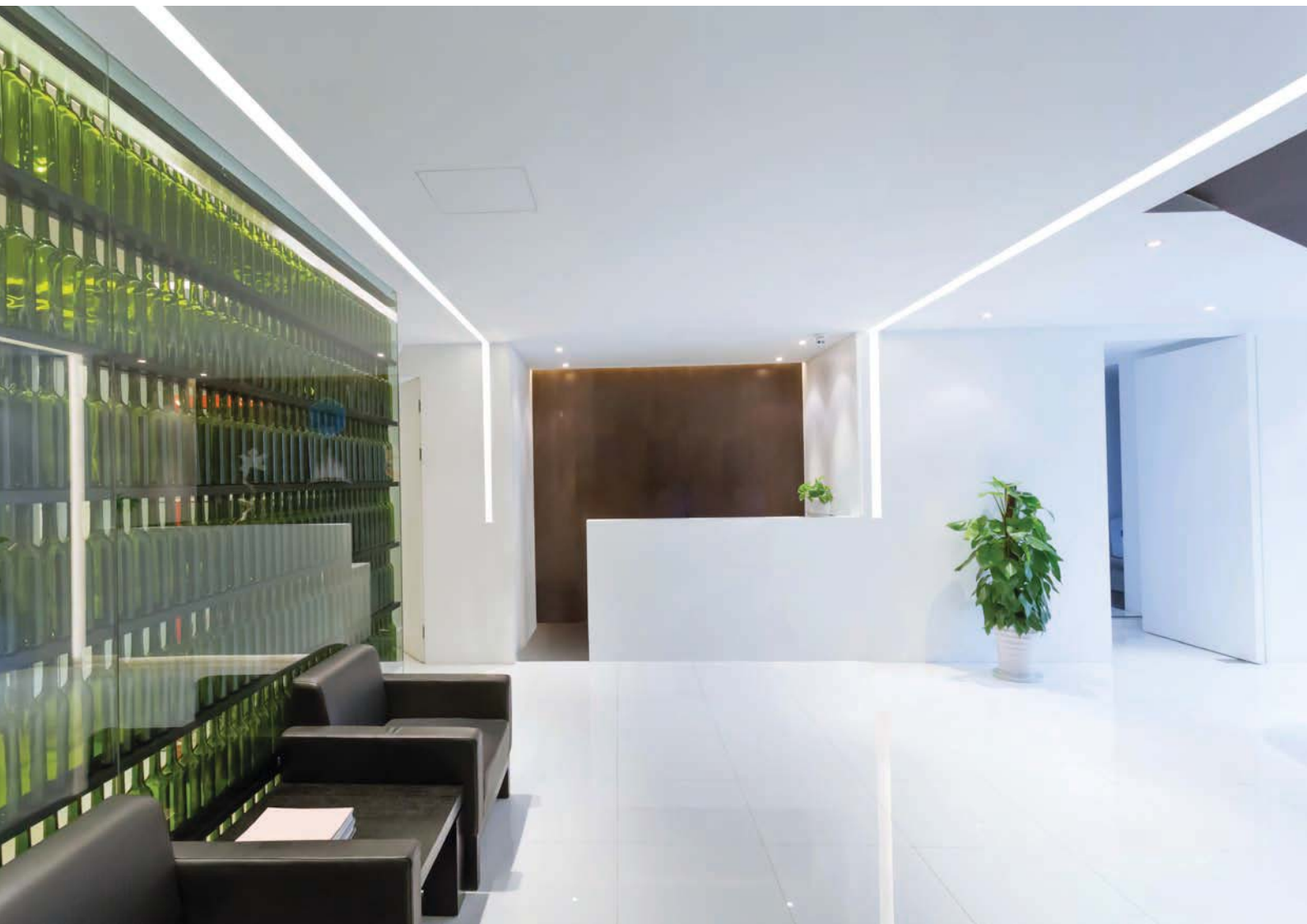



**6655** 1 kg

.01 15W 24V 2051lm 4000K

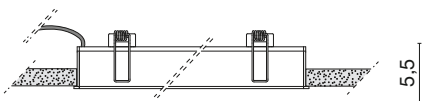
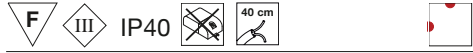

5,5

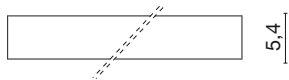

5,4

102

.01 101,5X4,8 cm.

**6656** 1,5 kg

.01 22,5W 24V 3076lm 4000K

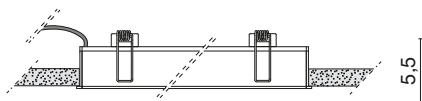

5,5

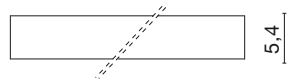

5,4

152

.01 151,5X4,8 cm.



**Accessories**



**0242-100/200/300**  
 Profilo a L per cartongesso  
 L profile for plasterboard

**Drivers**



**0156** 24V 25W



**0157** 24V 72W



**0160** 24V 50W



**0162** 24V 150W



**0164**  
 Dimmer 24V 120W



**0167**  
 Dimmer 24V 22W



**0110/DIM**  
 Dimmer 12/24V



**0115/EM**  
 Emergency Unit



Lunghezze superiori ai 3 metri si ottengono accostando i singoli elementi, il foro d'incasso si calcola con la seguente formula:  
 Configurations longer than 3 meters can be obtained by putting single fittings side by side in a row, the cutout length can be calculated with the formula hereunder:

Esempi - Examples  4,8xL cm.

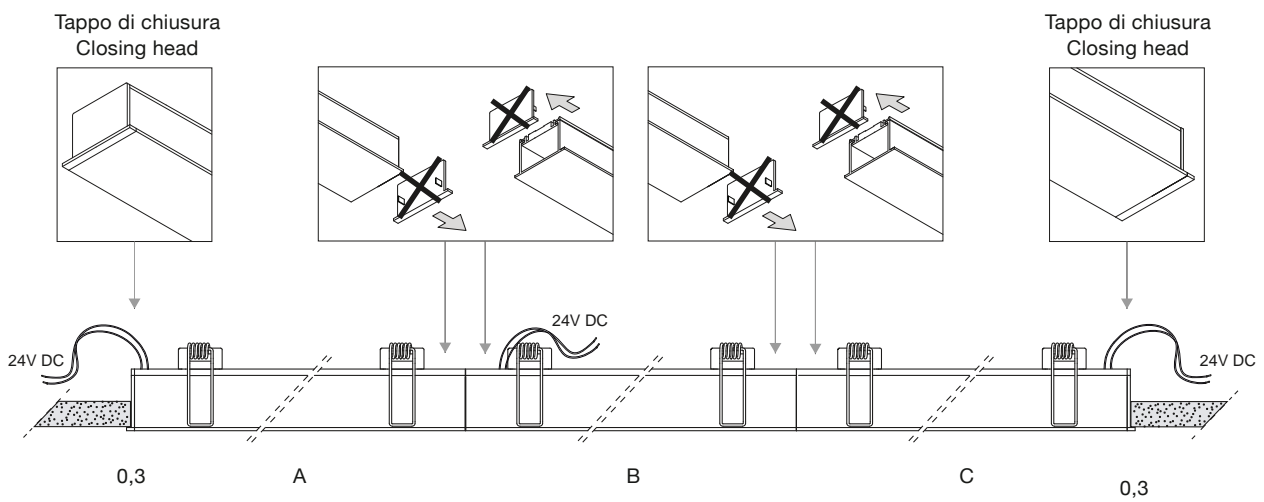

A B C = Lunghezza delle lampade senza tappi di chiusura. Lamps lenght without closing heads.

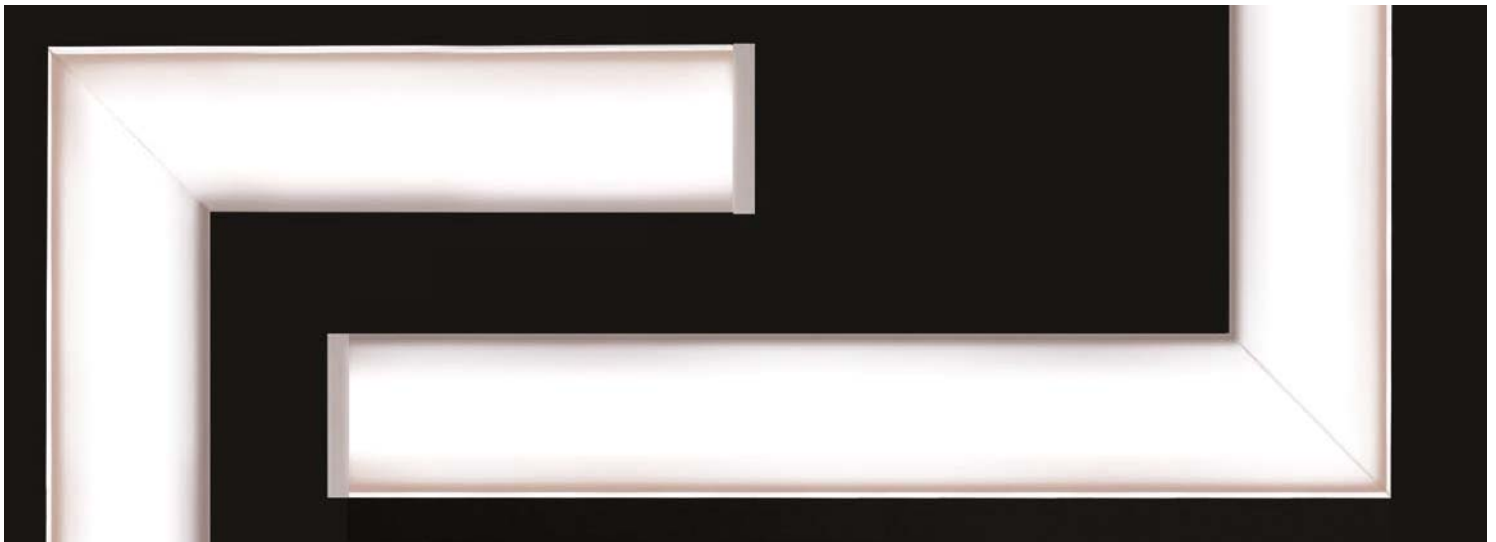

Su richiesta sono disponibili soluzioni angolari a 90°  
 90° angled options are available upon request

# SU MISURA - CUSTOM SIZE

Tabella lunghezze disponibili. Le misure si riferiscono alle lunghezze totali delle lampade comprese di tappi terminali.

N.B. senza tappi: - 1 cm.

Table of available lengths. Measures are referred to complete fixtures including closing heads.

Attention: Without closing heads: - 1cm.

cm.	watt	 cm.	white 4000 K (W)	lm.	warm white 3000 K (WW)	lm.	RGB
12	1,5W	11,5 x 4,8	A6655.01/10/W	205,1	A6655.01/10/WW	198	A6655.01/10/RGB
22	3W	21,5 x 4,8	A6655.01/20/W	410,2	A6655.01/20/WW	364	A6655.01/20/RGB
32	4,5W	31,5 x 4,8	A6655.01/30/W	615,3	A6655.01/30/WW	594	A6655.01/30/RGB
42	6W	41,5 x 4,8	A6655.01/40/W	820,4	A6655.01/40/WW	792	A6655.01/40/RGB
52	7,5W	51,5 x 4,8	A6655.01/50/W	1025,5	A6655.01/50/WW	990	A6655.01/50/RGB
62	9W	61,5 x 4,8	A6655.01/60/W	1230,6	A6655.01/60/WW	1188	A6655.01/60/RGB
72	10,5W	71,5 x 4,8	A6655.01/70/W	1435,7	A6655.01/70/WW	1386	A6655.01/70/RGB
82	12W	81,5 x 4,8	A6655.01/80/W	1640,8	A6655.01/80/WW	1584	A6655.01/80/RGB
92	13,5W	91,5 x 4,8	A6655.01/90/W	1845,9	A6655.01/90/WW	1782	A6655.01/90/RGB
102	15W	101,5 x 4,8	<b>6655.01*</b>	2051	A6655.01/100/WW	1980	<b>6657.01*</b>
112	16,5W	111,5 x 4,8	A6655.01/110/W	2256,1	A6655.01/110/WW	2178	A6655.01/110/RGB
122	18W	121,5 x 4,8	A6655.01/120/W	2461,2	A6655.01/120/WW	2370	A6655.01/120/RGB
132	19,5W	131,5 x 4,8	A6655.01/130/W	2666,3	A6655.01/130/WW	2574	A6655.01/130/RGB
142	21W	141,5 x 4,8	A6655.01/140/W	2871,4	A6655.01/140/WW	2772	A6655.01/140/RGB
152	22,5W	151,5 x 4,8	<b>6656.01*</b>	3076,5	A6655.01/150/WW	2970	<b>6658.01*</b>
162	24W	161,5 x 4,8	A6655.01/160/W	3281,6	A6655.01/160/WW	3168	A6655.01/160/RGB
172	25,5W	171,5 x 4,8	A6655.01/170/W	3486,7	A6655.01/170/WW	3366	A6655.01/170/RGB
182	27W	181,5 x 4,8	A6655.01/180/W	3691,8	A6655.01/180/WW	3564	A6655.01/180/RGB
192	28,5W	191,5 x 4,8	A6655.01/190/W	3896,9	A6655.01/190/WW	3762	A6655.01/190/RGB
202	30W	201,5 x 4,8	A6655.01/200/W	4102	A6655.01/200/WW	3960	A6655.01/200/RGB
212	31,5W	211,5 x 4,8	A6655.01/210/W	4307,1	A6655.01/210/WW	4158	A6655.01/210/RGB
222	33W	221,5 x 4,8	A6655.01/220/W	4512,2	A6655.01/220/WW	4356	A6655.01/220/RGB
232	34,5W	231,5 x 4,8	A6655.01/230/W	4717,3	A6655.01/230/WW	4554	A6655.01/230/RGB
242	36W	241,5 x 4,8	A6655.01/240/W	4922,4	A6655.01/240/WW	4752	A6655.01/240/RGB
252	37,5W	251,5 x 4,8	A6655.01/250/W	5127,5	A6655.01/250/WW	4950	A6655.01/250/RGB
262	39W	261,5 x 4,8	A6655.01/260/W	5332,6	A6655.01/260/WW	5148	A6655.01/260/RGB
272	40,5W	271,5 x 4,8	A6655.01/270/W	5537,7	A6655.01/270/WW	5346	A6655.01/270/RGB
282	42W	281,5 x 4,8	A6655.01/280/W	5732,8	A6655.01/280/WW	5544	A6655.01/280/RGB
292	43,5W	291,5 x 4,8	A6655.01/290/W	5947,9	A6655.01/290/WW	5742	A6655.01/290/RGB
302	45W	301,5 x 4,8	A6655.01/300/W	6153	A6655.01/300/WW	5940	A6655.01/300/RGB

\*Articolo standard a catalogo

\*Standard a catalogue item