

codice controcassa
rough-in housing code
150.--

codice colori
colour codes
 .05 grigio antracite
anthracite grey
 .13 grigio chiaro
light grey

5200.ECS.T-- 32 W 1 Led 3000 K 3312 lm
5200.EDS.T-- 32 W 1 Led 4000 K 3460 lm
 220-240 V 50/60 HZ
 vetro trasparente *clear diffuser*
 alimentatore incluso *led driver integral*

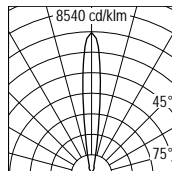
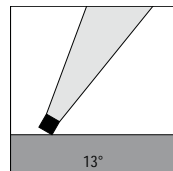

H (m)	Ø (m)	lux med. 3000 K	lux max. 3000 K	lux med. 4000 K	lux max. 4000 K
5	1.17	550	1097	592	1182
4	0.94	859	1714	926	1847
3	0.70	1528	3048	1646	3283
2	0.47	3437	6858	3703	7387
1	0.23	13749	27430	14811	29548

5200.ECM.T-- 32 W 1 Led 3000 K 3312 lm
5200.EDM.T-- 32 W 1 Led 4000 K 3460 lm
 220-240 V 50/60 HZ
 vetro trasparente *clear diffuser*
 alimentatore incluso *led driver integral*

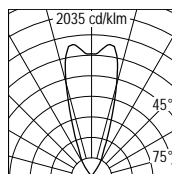
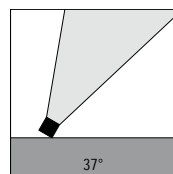

H (m)	Ø (m)	lux med. 3000 K	lux max. 3000 K	lux med. 4000 K	lux max. 4000 K
5	3.37	115	248	120	259
4	2.69	180	387	188	404
3	2.02	230	688	334	719
2	1.35	719	1548	751	1618
1	0.67	2876	6193	3004	6470

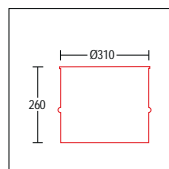
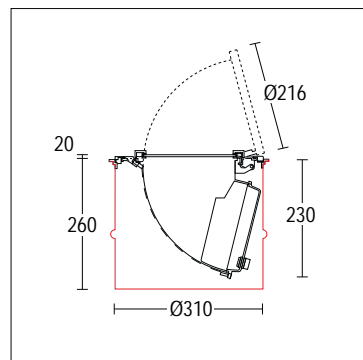

codice controcassa
rough-in housing code
150.--

codice colori
colour codes
 .05 grigio antracite
anthracite grey
 .13 grigio chiaro
light grey

5200.17M.T-- 35 W HIT G12 3300 lm
 230 V 50 HZ
 vetro trasparente *clear diffuser*
 alimentatore ferromagnetico incluso
conventional ballast integral

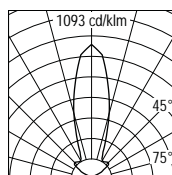
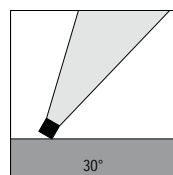

H (m)	Ø (m)	lux med.	lux max.
5	2.75	65	144
4	2.20	102	225
3	1.65	181	401
2	1.10	406	901
1	0.55	1626	3606

5200.19M.T-- 70 W HIT G12 6600 lm
 230 V 50 HZ
 vetro trasparente *clear diffuser*
 alimentatore ferromagnetico incluso
conventional ballast integral

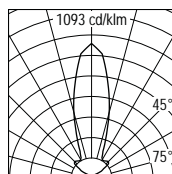
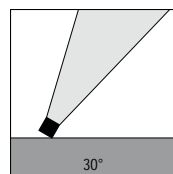

H (m)	Ø (m)	lux med.	lux max.
5	2.75	130	288
4	2.20	203	451
3	1.65	361	801
2	1.10	813	1803
1	0.55	3251	7211

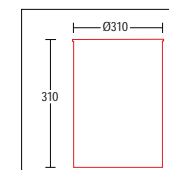
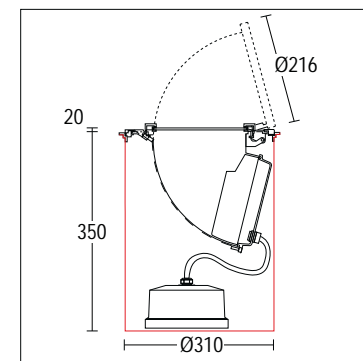
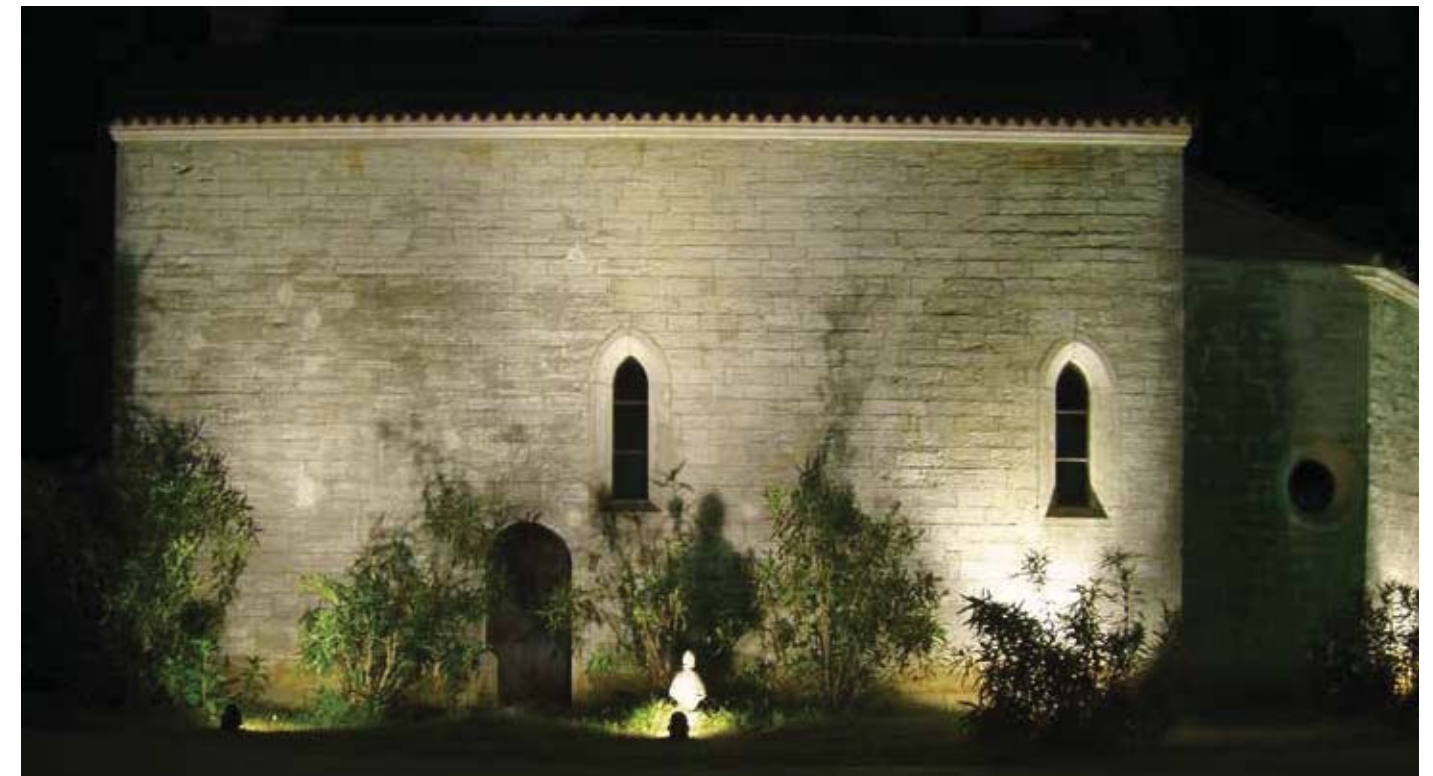

codice controcassa
rough-in housing code
151.--

codice colori
colour codes
 .05 grigio antracite
anthracite grey
 .13 grigio chiaro
light grey

5201.21M.T-- 150 W HIT G12 14000 lm
 230 V 50 HZ
 vetro trasparente *clear diffuser*
 alimentatore ferromagnetico incluso
conventional ballast integral

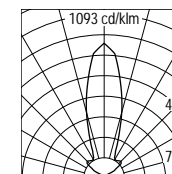
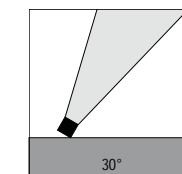

H (m)	Ø (m)	lux med.	lux max.
5	2.75	276	612
4	2.20	431	956
3	1.65	766	1700
2	1.10	1724	3824
1	0.55	6896	15296

Accessori Accessories

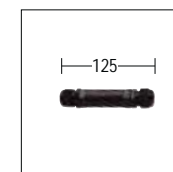

276
Connettore rapido IP 68
IP 68 fast connector

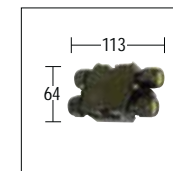

279
Connettore per cablaggio in cascata IP 68
IP 68 connector for through wiring



714 grigio antracite *anthracite grey*
715 grigio chiaro *light grey*
 Visiera in ferro
Steel clow