

# COSMO LED ALFA



**Application:** urban roads, pedestrians, parkings

**Assembly:** on extension arms with  $\varnothing 60$  x 100 mm ending

**Ingress protection:** IP 66 for the optical part and the driver

**Material:** anodised aluminium alloy

**Colour:** inox / black

**Optical system:** PMMA optics, interchangeable LED module

**Number of LEDs:** 24

**Operating temperature range:** from  $-40^{\circ}\text{C}$  to  $+40^{\circ}\text{C}$

**Expected useful lifetime:** L90F10 – 50 000 h, L80F20 – 100 000 h

**CRI:** >70 for 5000K, 4000K; >80 for 3500K

**Corrective factor S/P:** 1,8 for 5000K; 1,45 for 3500K; 1,55 for 4000K, 5000K

**Input voltage frequency:** 50 - 60Hz

**Power factor:**  $\geq 0.95$

**Inrush current:** : 57A / 210 $\mu\text{s}$

Luminaire COSMO LED ALFA has the possibility to connect to an external control system via DALI interface (optionally via analog signal 1- 10V).



Code	Symbol	LED power	Luminaire Power consumption	LED forward current	Colour temperature (CCT)	LEDs luminous flux <sup>2)</sup>	Luminaire luminous flux <sup>2)</sup>	Luminous efficacy	Unit volume	Luminaire net weight
<b>2212033/3/...</b> <sup>1)</sup>	COSMO LED ALFA 48	48W	55W	700mA	3500K	7 000lm	6550lm	119lm/W	0,073m <sup>3</sup>	11kg
<b>2212033/4/...</b> <sup>1)</sup>	COSMO LED ALFA 48	48W	55W	700mA	4000K	7 300lm	6800lm	124lm/W	0,073m <sup>3</sup>	11kg
<b>2212033/6/...</b> <sup>1)</sup>	COSMO LED ALFA 48	48W	55W	700mA	5000K	8 150lm	7100lm	129lm/W	0,073m <sup>3</sup>	11kg
<b>2212034/3/...</b> <sup>1)</sup>	COSMO LED ALFA 60	60W	67W	830mA	3500K	8 050lm	7700lm	115lm/W	0,073m <sup>3</sup>	11kg
<b>2212034/4/...</b> <sup>1)</sup>	COSMO LED ALFA 60	60W	67W	830mA	4000K	8 950lm	8000lm	119lm/W	0,073m <sup>3</sup>	11kg
<b>2212034/6/...</b> <sup>1)</sup>	COSMO LED ALFA 60	60W	67W	830mA	5000K	9 350lm	8400lm	125lm/W	0,073m <sup>3</sup>	11kg
<b>2212035/3/...</b> <sup>1)</sup>	COSMO LED ALFA 72	72W	80W	1000mA	3500K	9 400lm	8950lm	112lm/W	0,073m <sup>3</sup>	11kg
<b>2212035/4/...</b> <sup>1)</sup>	COSMO LED ALFA 72	72W	80W	1000mA	4000K	10 450lm	9300lm	116lm/W	0,073m <sup>3</sup>	11kg
<b>2212035/6/...</b> <sup>1)</sup>	COSMO LED ALFA 72	72W	80W	1000mA	5000K	10 950lm	9750lm	122lm/W	0,073m <sup>3</sup>	11kg

1) Symbol of chosen optical system eg. **2212035/6/T2** is **COSMO LED ALFA 72 5000K with T2 optical system**

2) tolerance +/- 3% due to LEDs accuracy

**Directive:** 2014/35/UE (Official Journal of the UE L 96/357 29.03.2014), 2014/30/UE (Official Journal of the UE L 96/79 29.03.2014), 2011/65/UE, 2009/125/EC

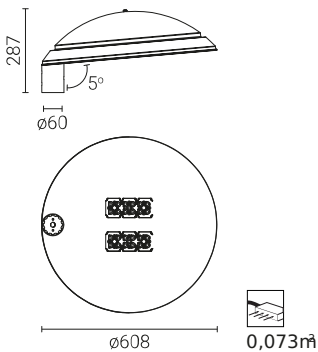

# COSMO LED ALFA

DW

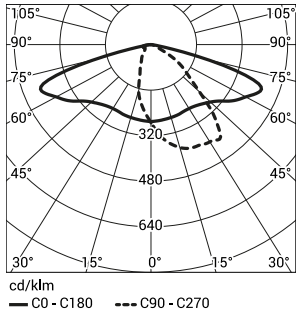

ME

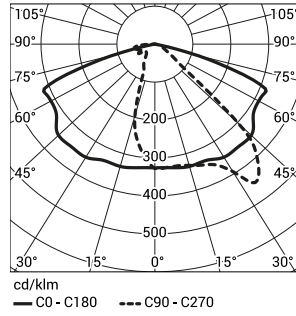

T2

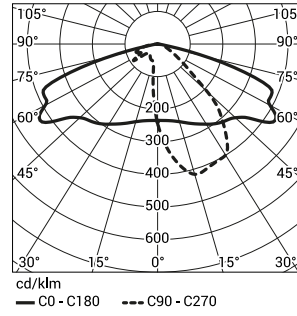

T3

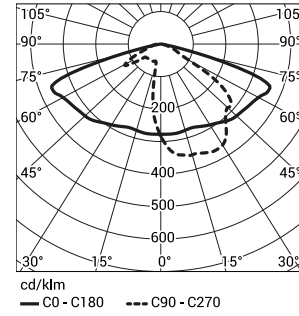

T4

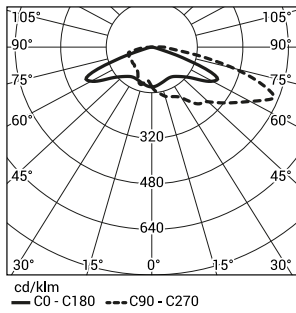

PP

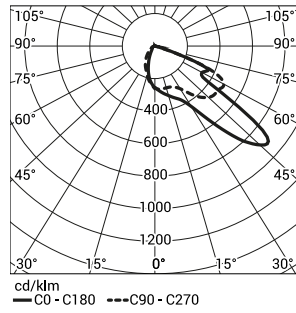

**Luminaire COSMO LED ALFA in standard has following functions of intelligent power supply:**

- Connection to outside control system by DALI interface (operation of analog signal 1-10V as an option),
- Possibility of programming multistage dimming of luminaire, up to 5 intervals in the range of from 10 to 100% of nominal power,
- Temperature protection of LED module (from overheating) in case of unintentional luminaire operation during the,
- Regulation of power / luminous flux – the option of setting another value than the catalogue in the range of 30-100% of nominal one,

**Acceptable quantity of luminaires COSMO LED ALFA on one circuit, protected by:**

**Overcurrent switches MCB type B or C**

Luminaire	Type	2A	4A	6A	10A	16A	20A	25A
COSMO LED ALFA 48, 60, 72W	B	0	1	3	6	10	12	15
	C	1	3	5	10	17	20	26

**Fuse – type gG and GL**

Luminaire	2A	4A	6A	10A	16A	20A	25A
COSMO LED ALFA 48, 60, 72W	2	6	9	17	27	34	43