

MINI / MEDIO

ROLL OVER

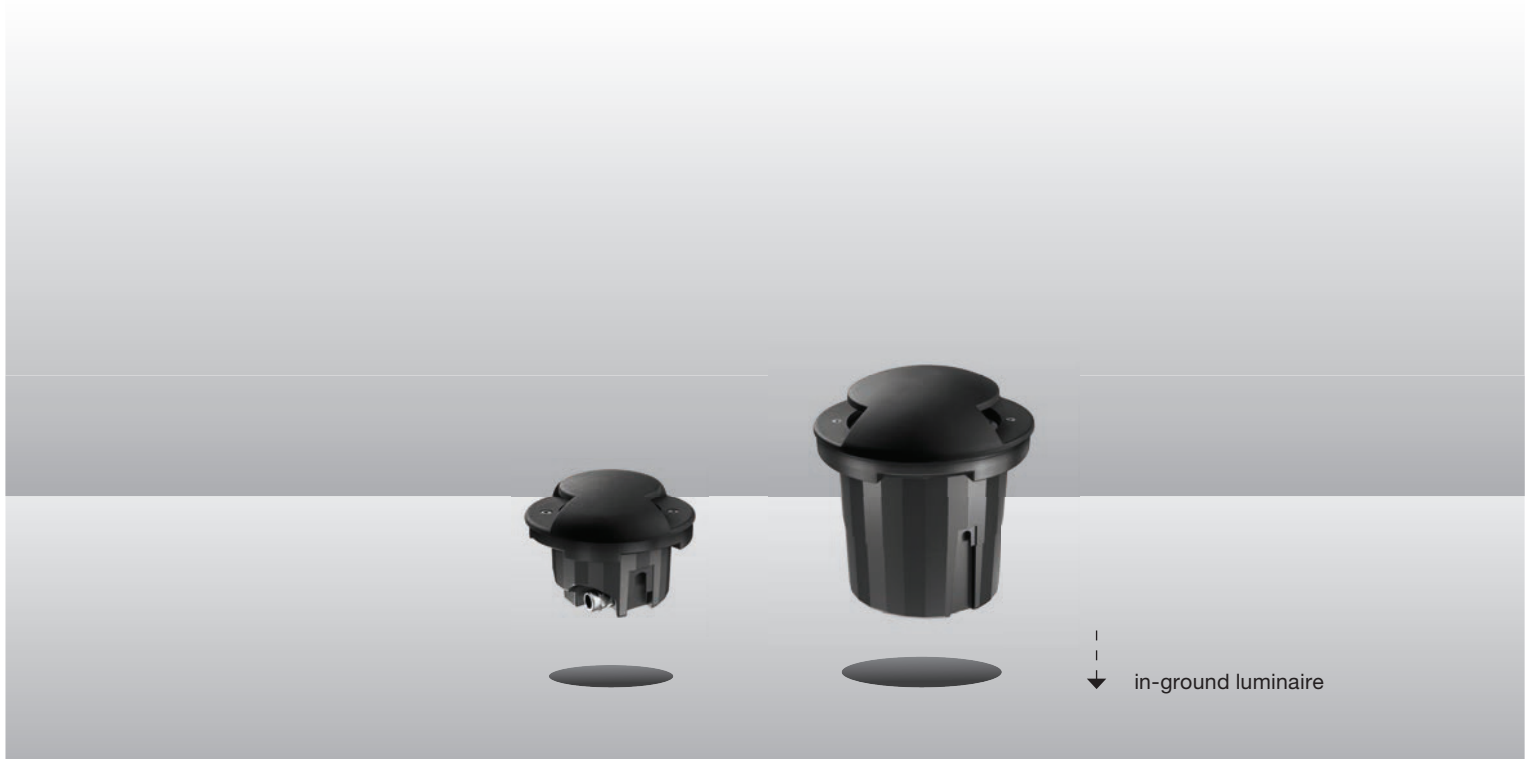

SOLUTIONS



MINI - 1 OPENING
ø 145 mm



MINI - 2 OPENINGS
ø 145 mm



MINI - 4 OPENINGS
ø 145 mm



MEDIO - 1 OPENING
ø 222 mm



MEDIO - 2 OPENINGS
ø 222 mm

COLOUR FINISH OF THE FIXTURES

↓ standard finish



.01 black

↓ colour finish on request



.02 white



.06 grey



.07 corten

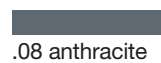

.08 anthracite

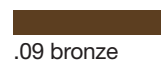

.09 bronze

↓ platek.eu

↓ product plus

Die-cast body and head manufactured in of EN 44300 aluminium alloy with very low copper content. A4 Stainless steel screws. Subjected to galvanic anodizing treatment divided into distinct phases: mechanical satin finishing, surface degreasing, anodic oxidation and final sealing. The product is painted following a continuous two step paint process (epoxy-based primer + polyester-based colour finish), which allows to generate a single thick protective coating which then generates a protective barrier against atmospheric agents and UV rays. IP68 protection with Full Dry system which avoids condensation inside the product. The Installation of the recessed housing in cast concrete with a 20-30 cm gravel soakaway. Only an IP68 connection to the power supply can guarantee the same protection to the fixture. Outer Housing and connector to be ordered separately.

↓ details

IP68 full dry

Product with IP68 Full Dry protection rating

IK10

Product with IK 10 mechanical impact rating

DALI on request

MEDIO is available on request in DALI

OPTICS AND SUGGESTIONS ON APPLICATIONS

↓ Light and optics

The continuous study and research to optimize the light effect of the Platek fixtures finds its roots in the development of new customised optics such as lenses and reflectors for different types of applications.

Download the pdf: platek.eu/plus



↓ MINI

1 Opening
1 x 90°

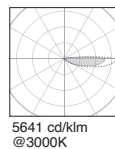

2 Openings
2 x 90°

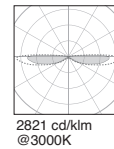
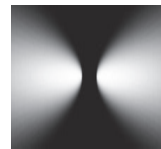

2 Openings
4 x 60°

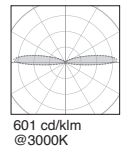
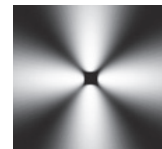

↓ MEDIO

1 Opening
120°



2 Openings
2 x 120°

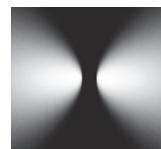

MINI

ROLL OVER

MINI 1 OPENING / LED white

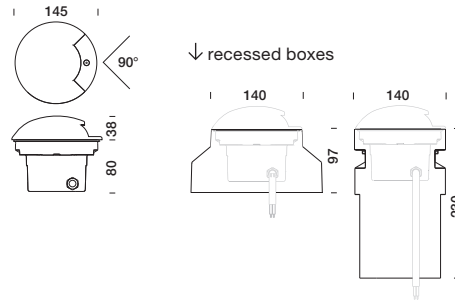

220-240V 0/50/60Hz . ⊕

↓ LED colour temperature configurator

cable: 1 m (3 x 1 mm²)

X = 9 → 2700K 190 lm ⁽¹⁾
X = 1 → 3000K 190 lm ⁽¹⁾
X = 6 → 4000K 200 lm ⁽¹⁾

IP68 Full Dry protection rating
 IK 10 mechanical resistance

↓ note
 recessed box to be ordered separately

drive over 2000 Kg



1 x 90°
 1 Opening
 2,5W LED CRI >80
 55 lm 2700K ⁽²⁾
 55 lm 3000K ⁽²⁾
 60 lm 4000K ⁽²⁾

84 09 0X6

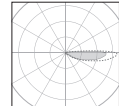

5641 cd/klm
 @3000K

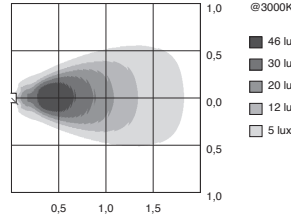

← example of installation
 Interdistance of fixtures: 3,5 m
 Code: 84 09 016

MINI 2 OPENINGS / LED white

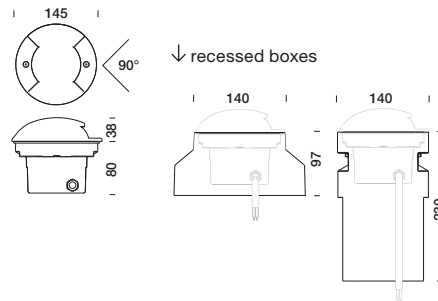

220-240V 0/50/60Hz . ⊕

↓ LED colour temperature configurator

cable: 1 m (3 x 1 mm²)

X = 9 → 2700K 380 lm ⁽¹⁾
X = 1 → 3000K 380 lm ⁽¹⁾
X = 6 → 4000K 400 lm ⁽¹⁾

IP68 Full Dry protection rating
 IK 10 mechanical resistance

↓ note
 recessed box to be ordered separately

drive over 2000 Kg



2 x 90°
 2 Openings
 4,2W LED CRI >80
 110 lm 2700K ⁽²⁾
 110 lm 3000K ⁽²⁾
 115 lm 4000K ⁽²⁾

84 09 7X6

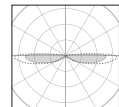

2821 cd/klm
 @3000K

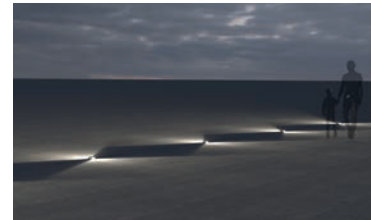
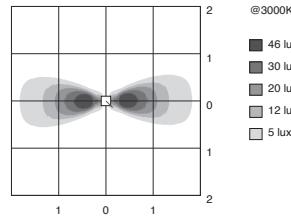

← example of installation
 Interdistance of fixtures: 3,5 m
 Code: 84 09 716

Standard delivery fixtures
 (3000K versions).

↓ standard finish
 .01 black

↓ colour finish on request
 .02 white

.06 grey

.07 corten

.08 anthracite

.09 bronze

⁽¹⁾ led data - ⁽²⁾ real data . Due the continuing technological developments the present data may vary from what is stated in the current catalogue. The Technical data available from the plaek.ue website are continuously updated in the data sheets.

MINI

ROLL OVER

MINI 4 OPENINGS / LED white

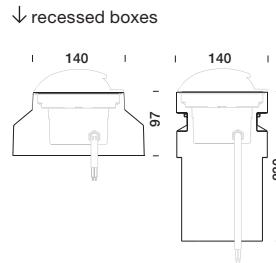
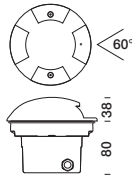

220-240V 0/50/60Hz . ⊕

↓ LED colour temperature configurator

cable: 1 m (3 x 1 mm²)

X = 9 → 2700K 760 lm (!)

X = 1 → 3000K 760 lm (!)

X = 6 → 4000K 800 lm (!)

IP68 Full Dry protection rating
IK 10 mechanical resistance

drive over 2000 Kg

↓ note
recessed box to be ordered separately



4 x 60°
4 Openings

7,4W LED CRI >80
215 lm 2700K (°)
215 lm 3000K (°)
225 lm 4000K (°)

84 09 8**X**6

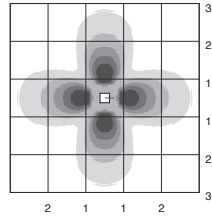
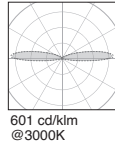

@3000K
6 lux
4 lux
3 lux
2 lux
1 lux



← example of installation

Interdistance of fixtures: 3,5 m

Code: 84 09 816

Accessories

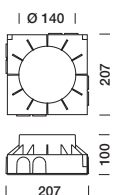

Recessed box
h. 100 mm
with square base
200 mm

89 45 015

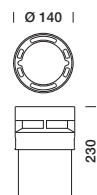

Recessed box
h. 230 mm

89 45 020



IP68 IN/OUT
connector for
3x4 mm² cable

89 17 004



IP68 connector for
3x1,5 mm² cable

89 17 014



MEDIO

ROLL OVER

MEDIO 1 OPENING / LED white

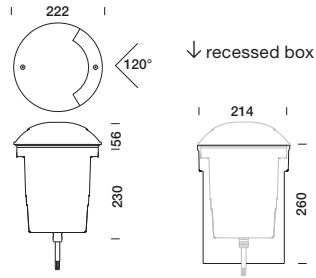

220-240V 0/50/60Hz . ⊕

cable: 1 m (3 x 1,50 mm²)

IP68 Full Dry protection rating
IK 10 mechanical resistance

drive over 2000 Kg

↓ LED colour temperature configurator

X = 9 → 2700K 380 lm ⁽¹⁾

X = 1 → 3000K 380 lm ⁽¹⁾

X = 6 → 4000K 400 lm ⁽¹⁾

↓ note

recessed box to be ordered separately



1 x 120°
1 Opening

4,7W LED CRI >80
110 lm 2700K ⁽²⁾
110 lm 3000K ⁽²⁾
115 lm 4000K ⁽²⁾

84 10 1X6

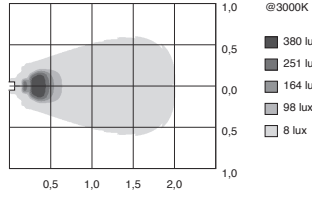
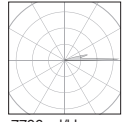

← example of installation

Interdistance of fixtures: 4 m

Code: 84 10 116

Standard delivery fixtures (3000K versions).

↓ standard finish
 .01 black

↓ colour finish on request
 .02 white

.06 grey

.07 corten

.08 anthracite

.09 bronze

⁽¹⁾ led data - ⁽²⁾ real data . A seguito del progresso tecnologico i dati presenti nel documento possono variare nel corso di validità del presente catalogo. Sul sito platek.eu potete trovare le schede tecniche create dinamicamente ed aggiornate alla data riportata sulla scheda stessa.

MEDIO

ROLL OVER

MEDIO 2 OPENINGS / LED white

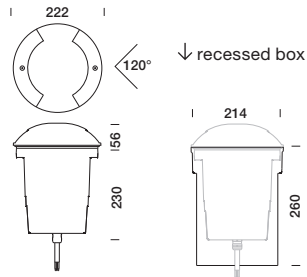

220-240V 0/50/60Hz . ⊕

cable: 1 m (3 x 1,50 mm²)

IP68 Full Dry protection rating
IK 10 mechanical resistance

drive over 2000 Kg

↓ LED colour temperature configurator

X = 9 → 2700K 760 lm (!)

X = 1 → 3000K 760 lm (!)

X = 6 → 4000K 800 lm (!)

↓ note

recessed box to be ordered separately



2 x 120° 8,3W LED CRI >80
2 Openings
240 lm 2700K (°)
240 lm 3000K (°)
250 lm 4000K (°)

84 10 2X6

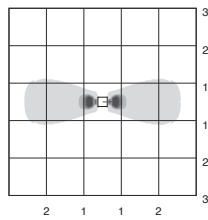
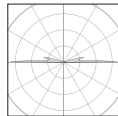

@3000K
409 lux
270 lux
176 lux
105 lux
8 lux



← example of installation

Interdistance of fixtures: 4 m

Code: 84 10 216

Accessories



Recessed box
h. 260 mm

89 45 030



IP68 IN/OUT
connector for
3x4 mm² cable

89 17 004



IP68 connector for
3x1,5 mm² cable

89 17 014